

MONTAGEVOORSCHRIFT

MOUNTING INSTRUCTIONS

INSTRUCCIONES DE MONTAJE

MONTAGE-ANLEITUNG

INSTRUCTIONS DE MONTAGE

# ZAROS V75

Voor uw veiligheid:borggat gebruiken  
 Pour votre sécurité:utiliser le trou de fixation  
 Für Ihre Sicherheit:das Sicherungsloch anwenden  
 For your security:use the locking hole

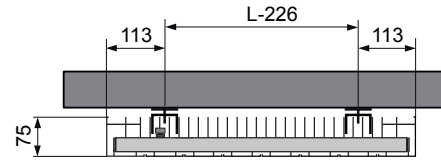
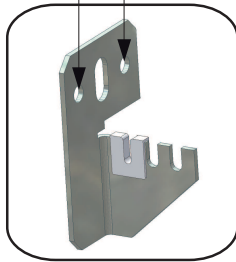

Werkdruk : Max.10 bar  
 Betriebsdruck : Max.10 bar  
 Pression de service : Max.10 bar  
 Operating pressure : Max.10 bar  
 Presión : Max.10 bar

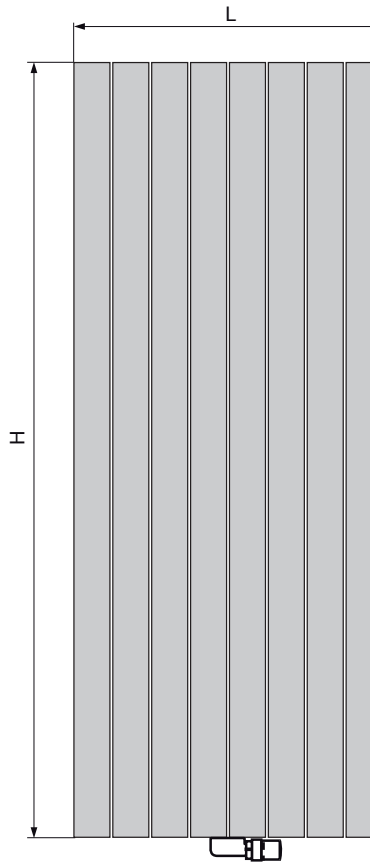
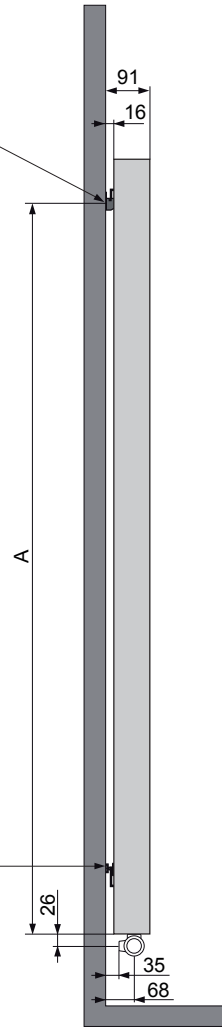
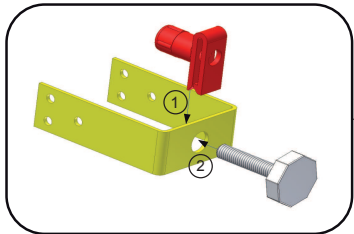

H	A
1600	1477
1800	1677
2000	1877
2200	2077

MONTAGEVOORSCHRIFT

MOUNTING INSTRUCTIONS

INSTRUCCIONES DE MONTAJE

MONTAGE-ANLEITUNG

INSTRUCTIONS DE MONTAGE

# ZAROS V100

Voor uw veiligheid: borggat gebruiken  
Pour votre sécurité: utiliser le trou de fixation  
Für Ihre Sicherheit: das Sicherungsloch anwenden  
For your security: use the locking hole

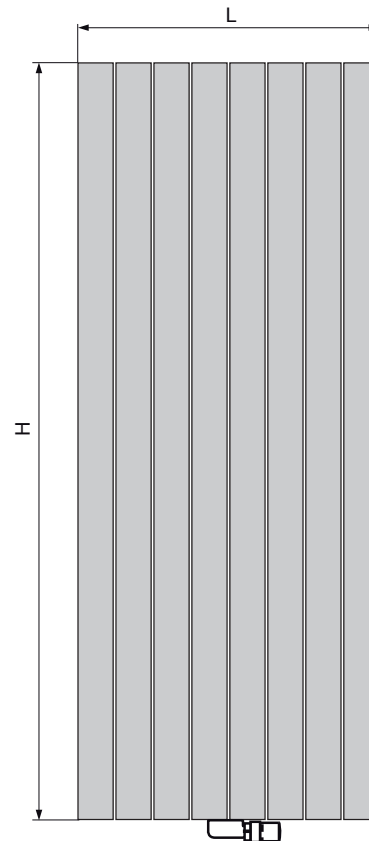
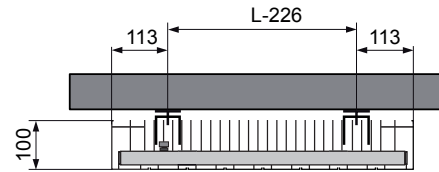
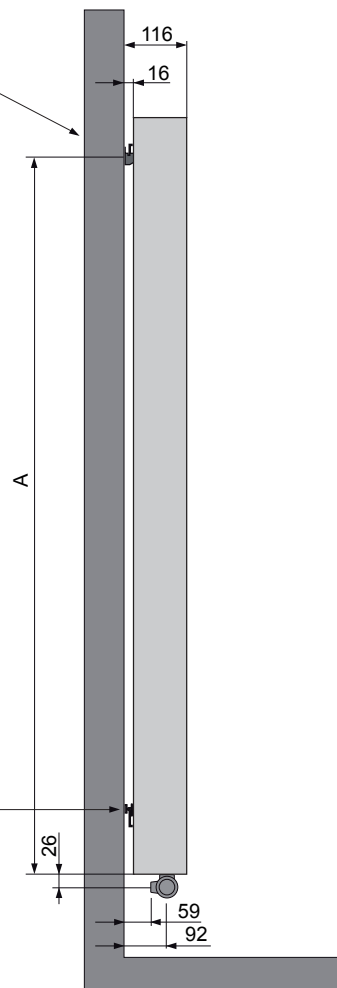
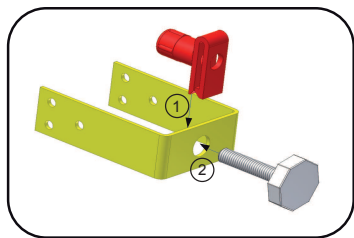
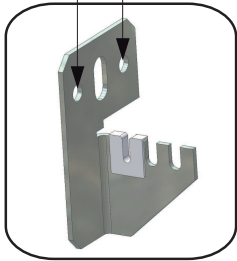

Werkdruk : Max.10 bar  
Betriebsdruck : Max.10 bar  
Pression de service : Max.10 bar  
Operating pressure : Max.10 bar  
Presión : Max.10 bar

H	A
1600	1477
1800	1677
2000	1877
2200	2077

# HOW TO USE THE AUTOMATIC AIRVENT

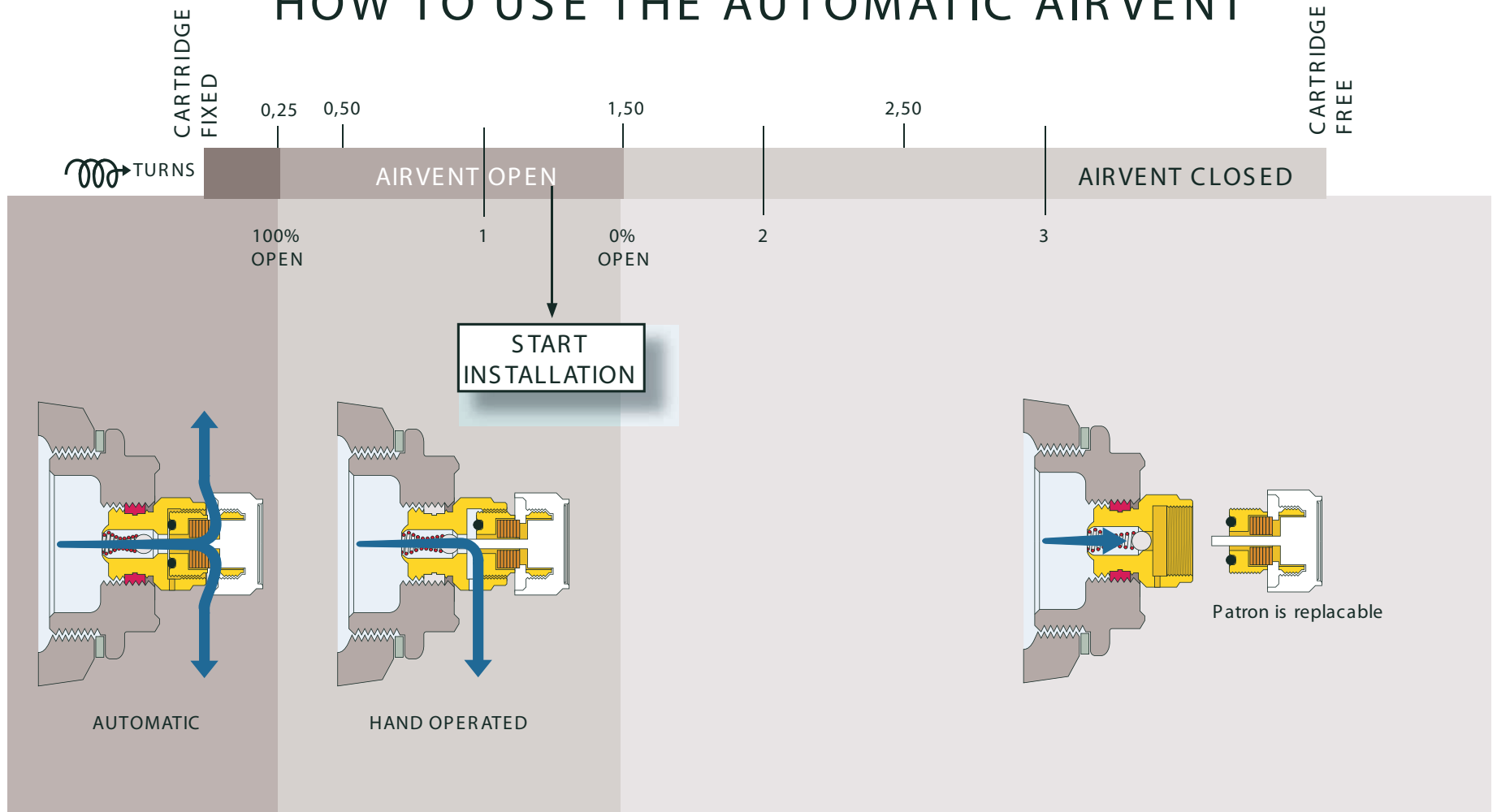

# HOW TO USE THE AUTOMATIC AIRVENT

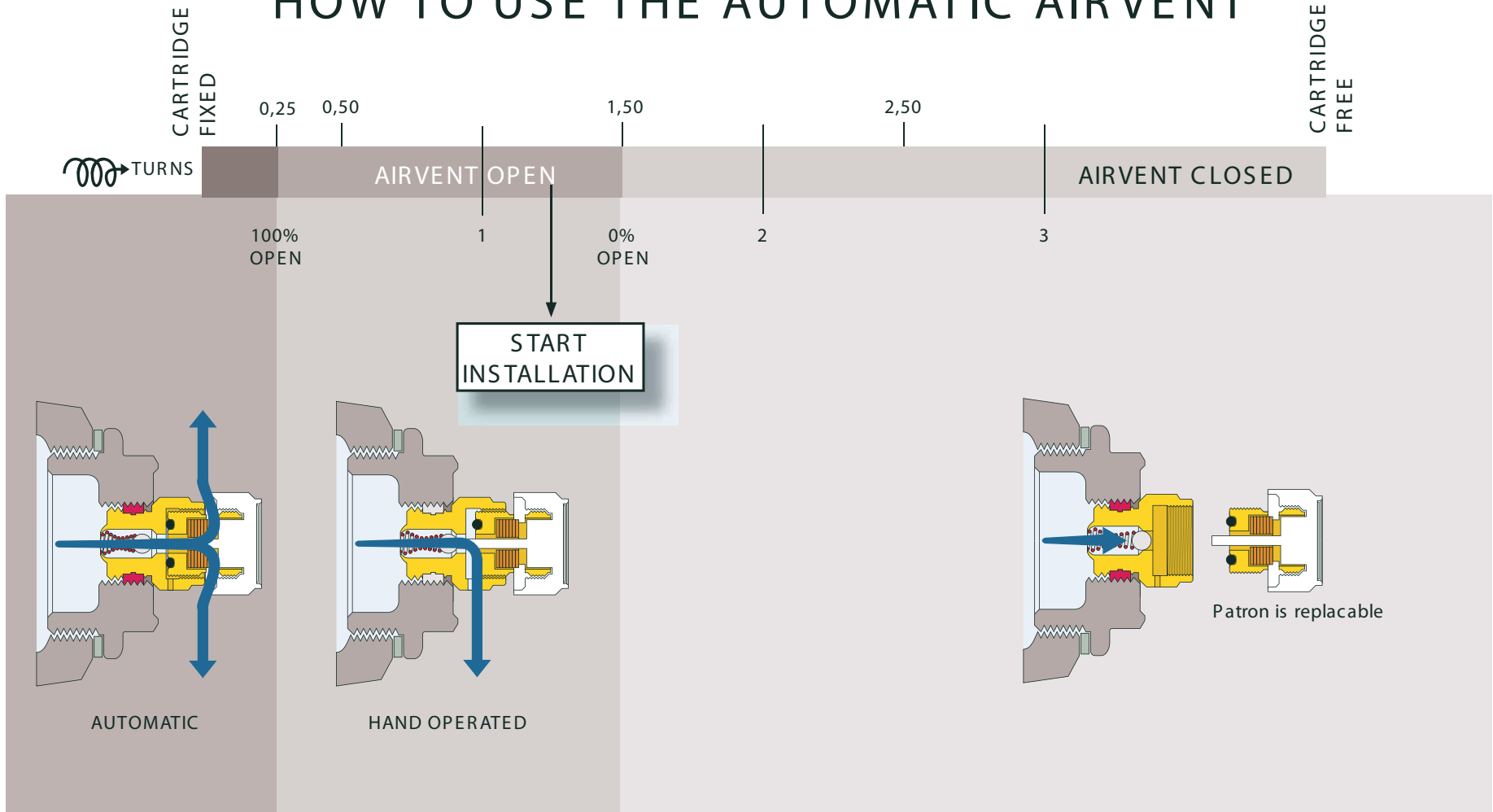

Voor uw veiligheid:borggat gebruiken  
 Pour votre sécurité:utiliser le trou de fixation  
 Für Ihre Sicherheit:das Sicherungsloch anwenden  
 For your security:use the locking hole

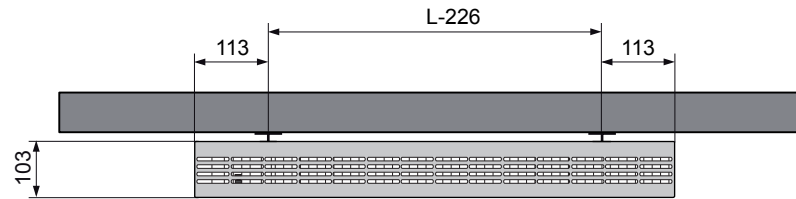
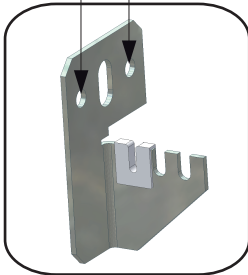

Werkdruk : Max.10 bar  
 Betriebsdruck : Max.10 bar  
 Pression de service : Max.10 bar  
 Operating pressure : Max.10 bar  
 Presión : Max.10 bar

2 ophangingen tot lengte 1500mm  
 3 ophangingen boven lengte 1500mm

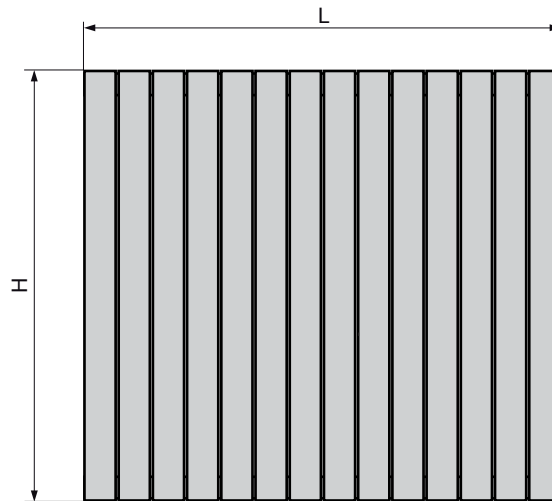
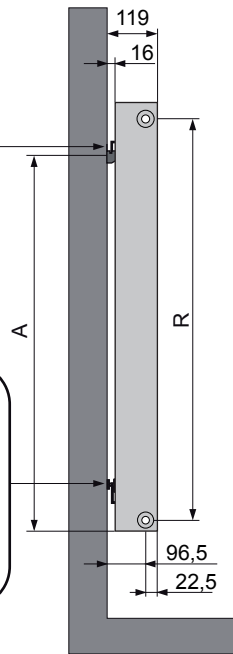
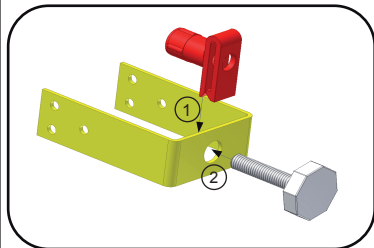

H	A	R
400	277	338,5
500	377	438,5
600	477	538,5
900	777	838,5
1400	1277	1338,5

Voor uw veiligheid:borggat gebruiken  
 Pour votre sécurité:utiliser le trou de fixation  
 Für Ihre Sicherheit:das Sicherungsloch anwenden  
 For your security:use the locking hole

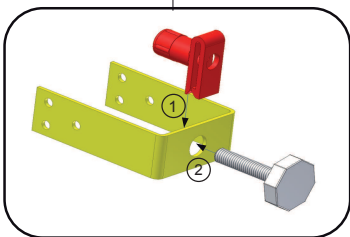
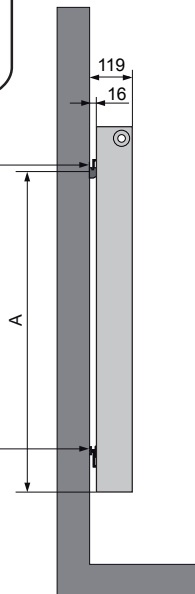
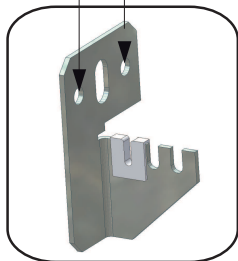

2 ophangingen tot lengte 1500mm  
 3 ophangingen boven lengte 1500mm

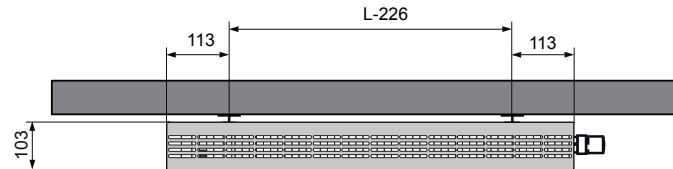

Werkdruk : Max.10 bar  
 Betriebsdruck : Max.10 bar  
 Pression de service : Max.10 bar  
 Operating pressure : Max.10 bar  
 Presión : Max.10 bar

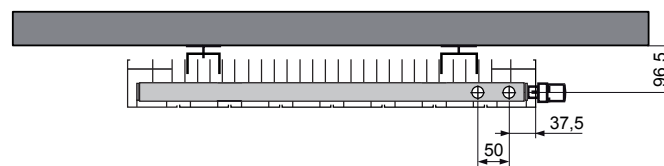
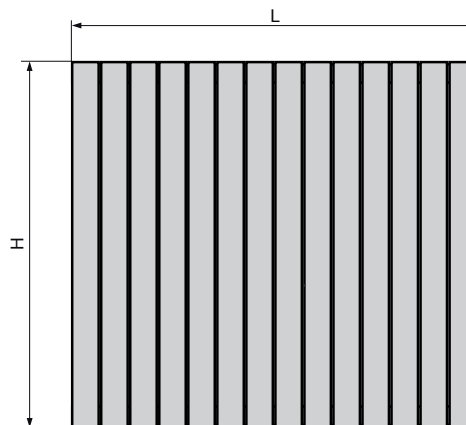
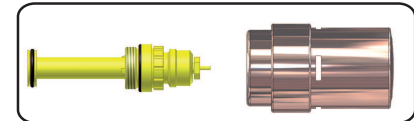

H	A
400	277
500	377
600	477
900	777
1400	1277

# HOW TO USE THE AUTOMATIC AIRVENT

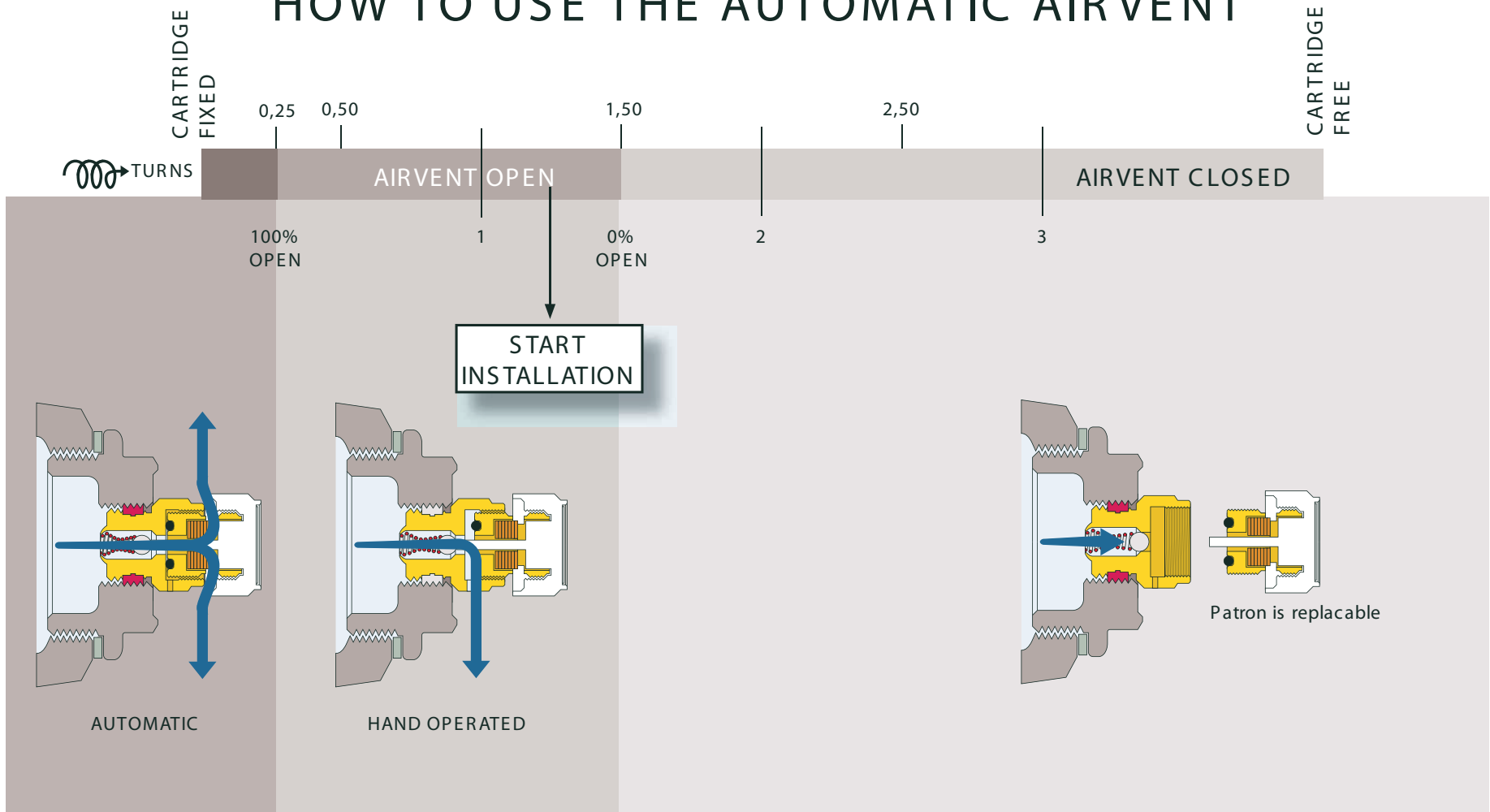

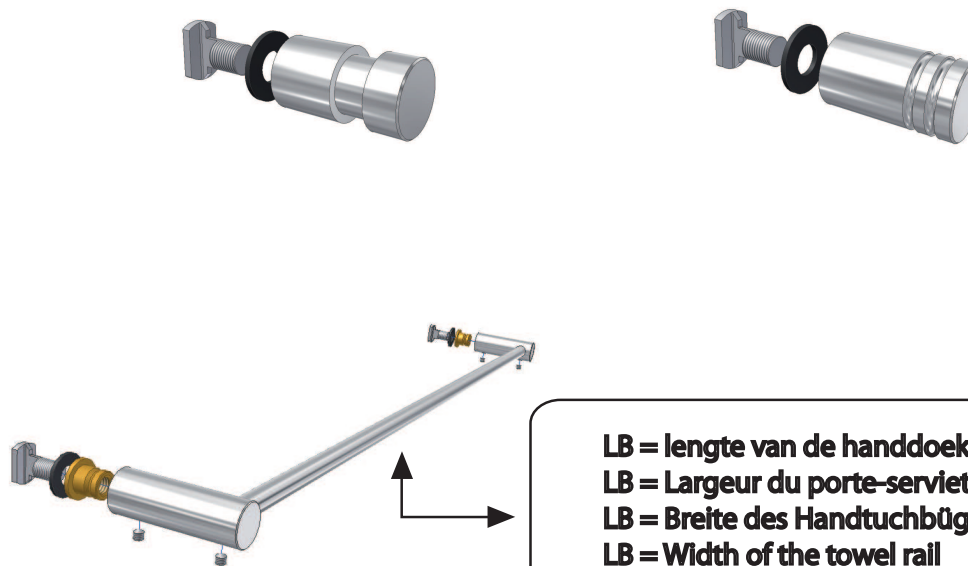
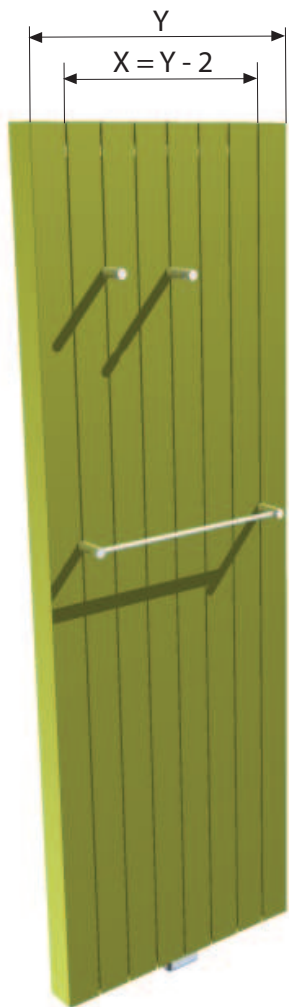

LB = lengte van de handdoekbeugel  
LB = Largeur du porte-serviettes  
LB = Breite des Handtuchbügels  
LB = Width of the towel rail

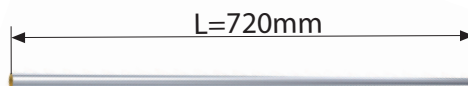

L	X=Y-2	LB
720	6	457
720	5	382
720	4	307
720	3	232

MONTAGEVOORSCHRIFT

MOUNTING INSTRUCTIONS

MONTAGE-ANLEITUNG

INSTRUCTIONS DE MONTAGE

# Luxe Acc. Zaros / Veltis H100

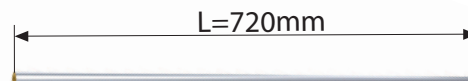
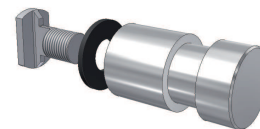
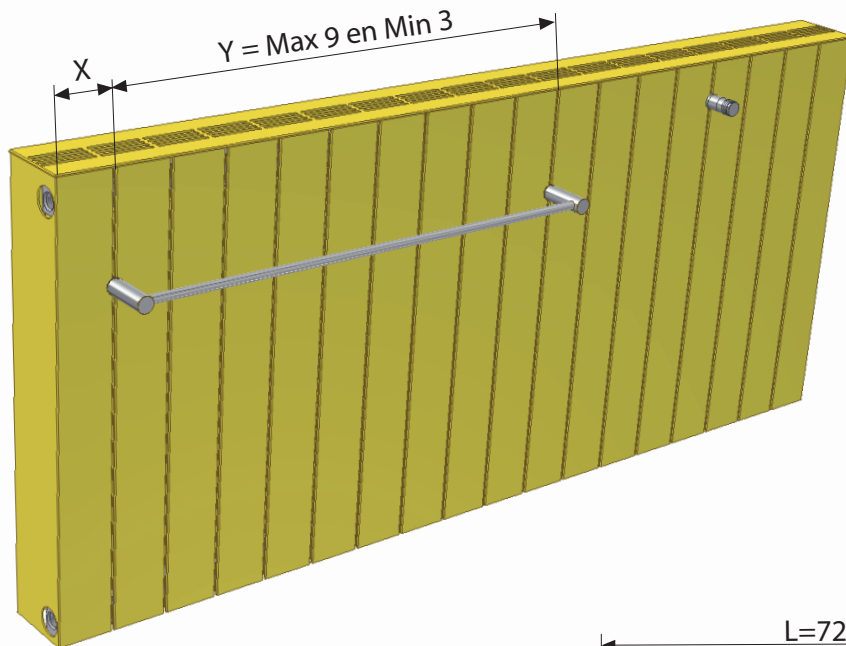

**LB = lengte van de handdoekbeugel**  
**LB = Largeur du porte-serviettes**  
**LB = Breite des Handtuchbügels**  
**LB = Width of the towel rail**

L	Y	LB
720	9	682
720	8	607
720	7	532
720	6	457
720	5	382
720	4	307
720	3	232