

STORAX®



LEUNINGEN



HEKWERKEN



BALUSTRADES



BALKONHEKKEN



INHOUD

● Overzicht standaardsystemen.....	pag. 1
≡ ARGENTUM ≡.....	pag. 2-3
≡ VANADIUM ≡	pag. 4-5
≡ SCANDIUM ≡.....	pag. 6-9
≡ RHODIUM ≡	pag. 10-11
≡ CORRIDIUM ≡.....	pag. 12-13
● Projecten.....	pag. 14-33

≡ ARGENTUM ≡



≡ VANADIUM ≡



≡ SCANDIUM ≡



≡ RHODIUM ≡



≡ CORRIDIUM ≡





- voor trappen en vides
- leverbaar in rvs of gemoffeld staal
- paneelvulling:
 - glas
 - geperforeerde staalplaat
- voldoet aan het Bouwbesluit



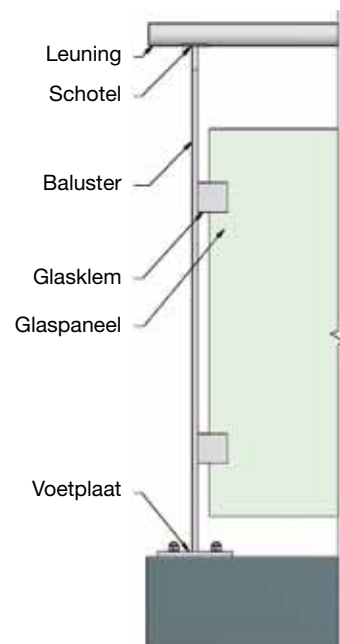
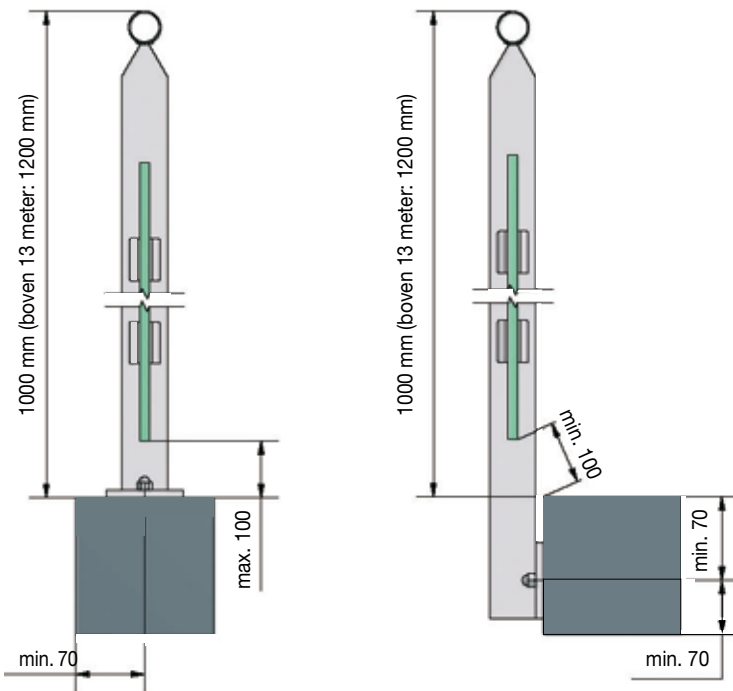
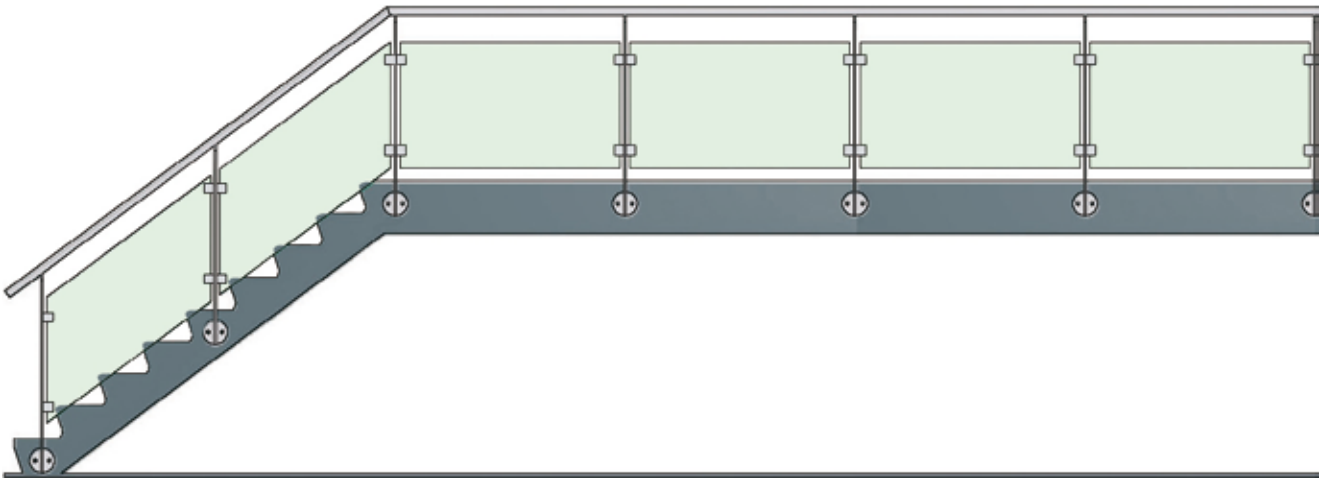

Technische informatie

Type:	Argentum
Baluster:	buis of stripbaluster met glasklemmen
Balusterafstand:	maximaal 1300 mm
Leuning:	buisleuning
Materiaalkeuze:	- roestvaststaal 304, geslepen korrel 320 - staal, thermisch verzinkt en/of gemoffeld in RAL kleur - combinatie van genoemde materiaalsoorten
Glas:	blank gehard en gelaagd glas
Glasdikte:	12 of 16 mm
Lijnlast:	0,8 kN/m

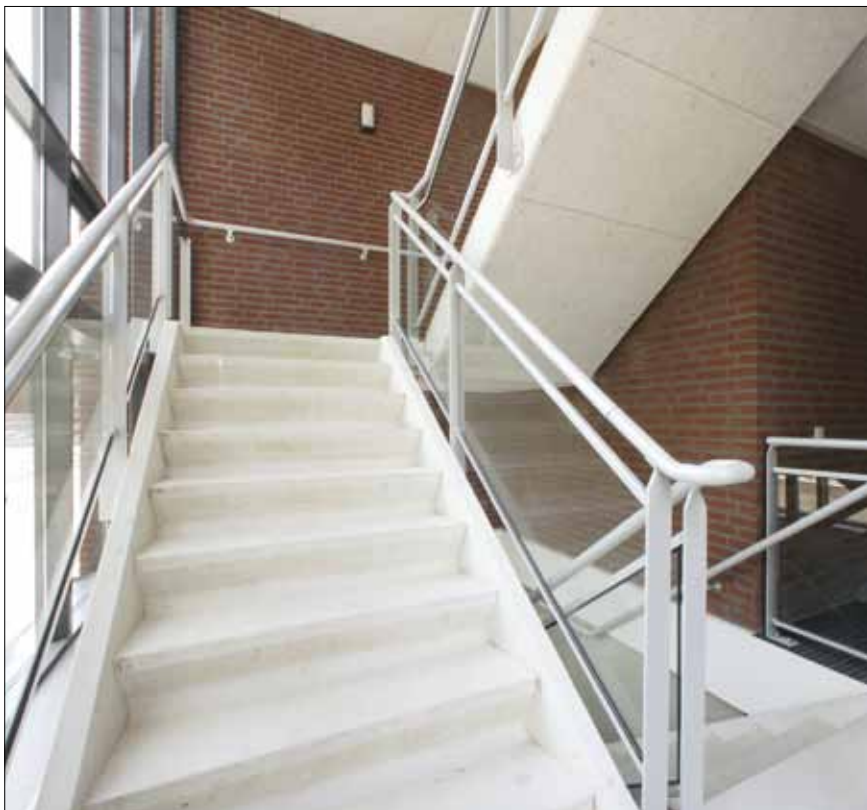

- voor binnen- en buitentoepassing
- voor trappen, vides en balkons
- leverbaar in rvs of gemoffeld staal
- paneelvulling: glas
- uitstekende prijs-kwaliteit verhouding
- voldoet aan het Bouwbesluit



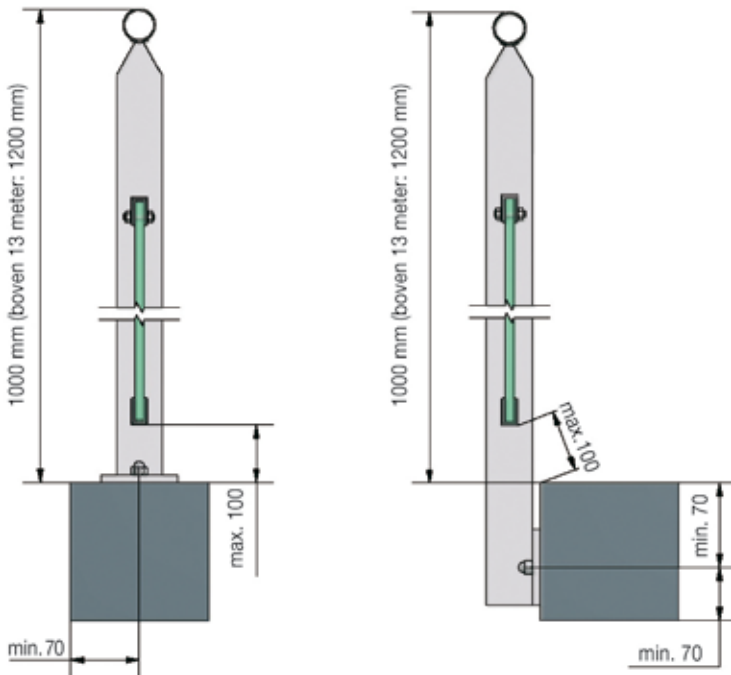
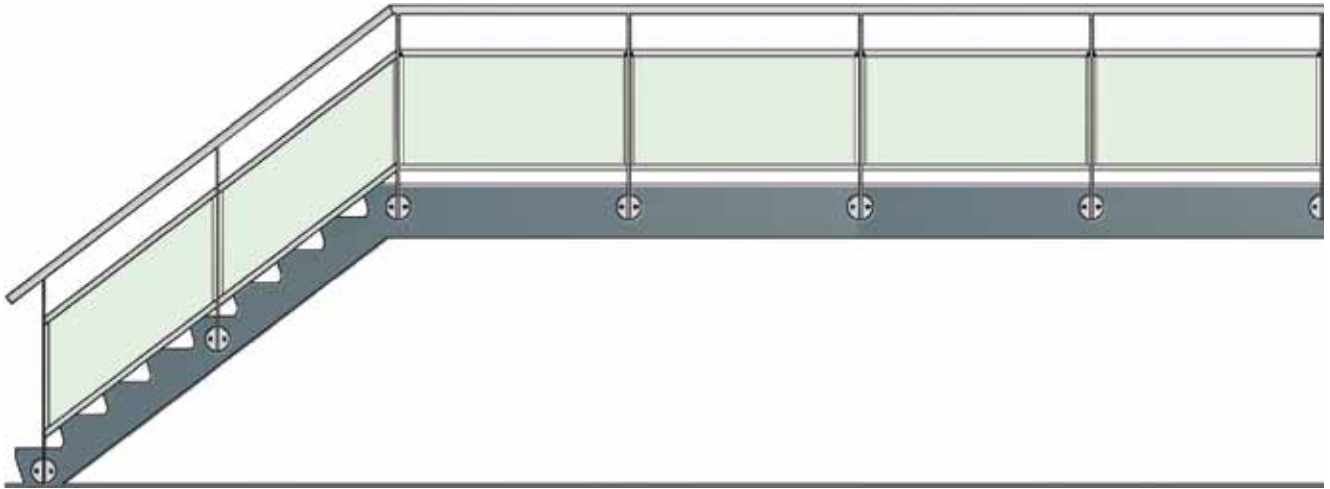

Technische informatie

Type:	Vanadium
Baluster:	stripbaluster
Balusterafstand:	maximaal 1300 mm
Leuning:	buisleuning
Glasprofielen:	U-profiel
Materiaalkeuze:	- roestvaststaal 304, geslepen korrel 320 - staal, thermisch verzinkt en/of gemoffeld in RAL kleur - combinatie van genoemde materiaalsoorten
Glas:	blank gelaagd glas
Glasdikte:	8 of 10 mm
Lijnlast:	0,8 kN/m

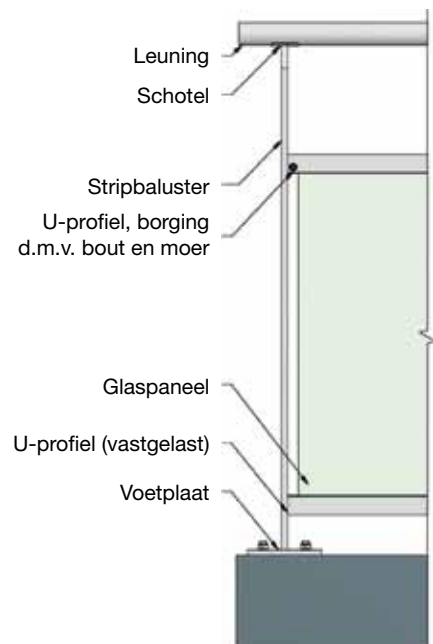



- voor binnen- en buitentoepassing
- voor vides, balkons en galerijen
- materiaal: geëxtrudeerd aluminium
- paneelvulling:
 - helder gelaagd glas
 - gelaagd glas met kleurfolie
- voldoet aan het Bouwbesluit
- balustradesysteem met vele varianten
- levering: compleet gemonteerd of als losse componenten voor zelfmontage



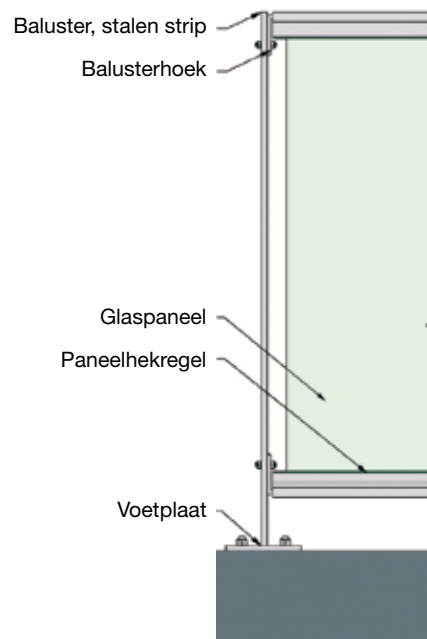
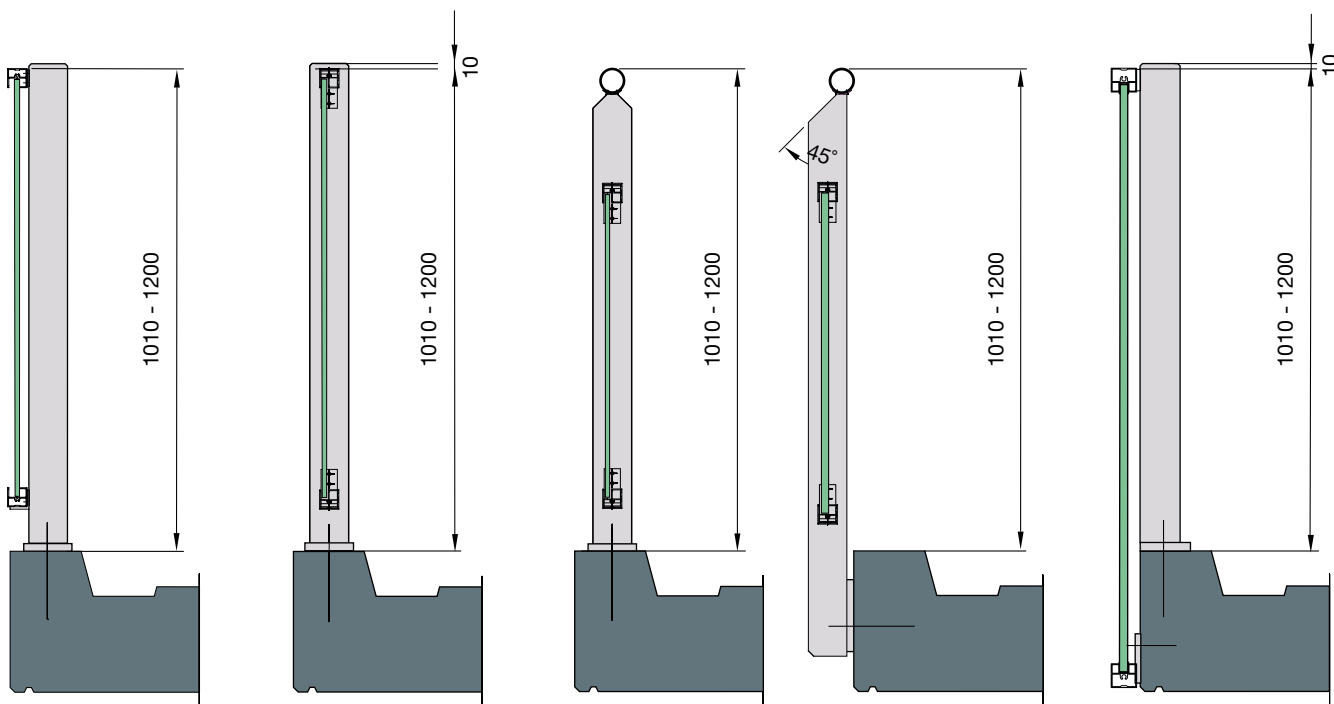
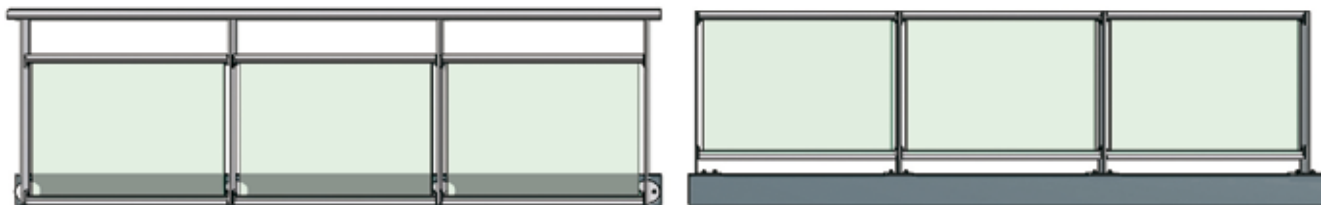

Technische informatie

Type:	Scandium
Baluster:	stripbaluster
Balusterafstand:	maximaal 1700 mm
Boven- en onderregel:	aluminium paneelhekgregel
Materiaalkeuze balusters:	- staal, thermisch verzinkt en/of gemoffeld in RAL kleur - aluminium gemoffeld in RAL kleur
Materiaal glasprofielen	- aluminium gemoffeld in RAL kleur - aluminium geanodiseerd
Glas:	blank gelaagd glas
Glasdikte:	8 of 10 mm
Lijnlast:	0,8 kN/m

Balusters

STX 8310

Baluster 50 x 50

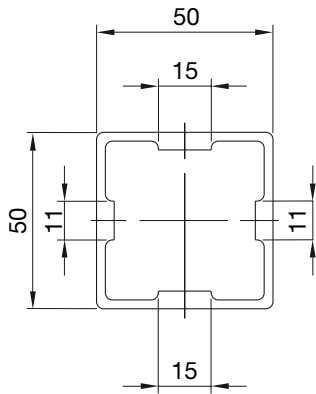

STX 8314

Baluster koker 80 x 40 x 4

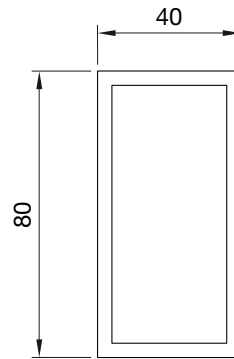

STX 8312

Baluster strip 80 x 12

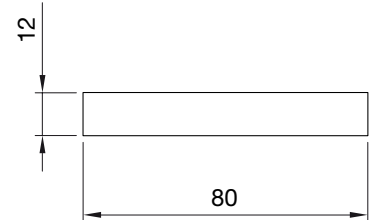

Leuningen

STX 8180

Leuning 80 x 42

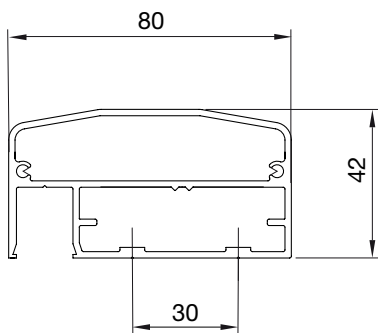

STX 8171

Leuning ovaal 100 x 60

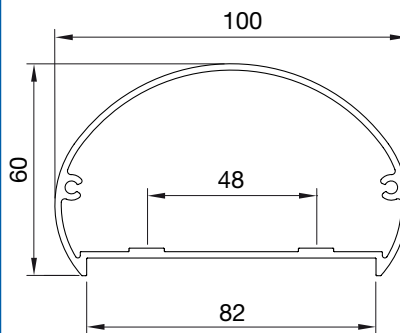

STX 8172

Leuning ovaal 1 sleuf

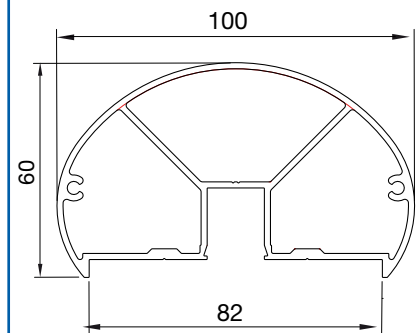

Tussenregels

STX 8250

Buis Ø 30

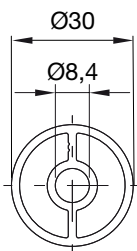

STX 8251

Buis Ø 30

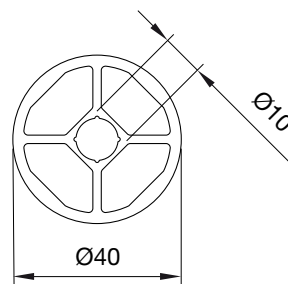

STX 8140

H-Glasprofiel 50 x 50

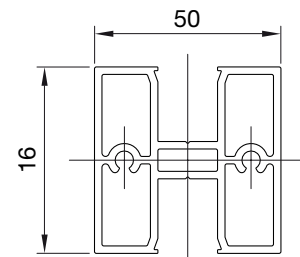

Glasprofielen

STX 8110

Glasprofiel 40 x 40

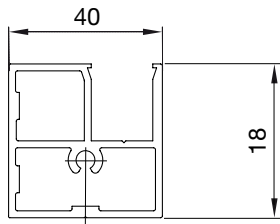

STX 8111

Glasprofiel 50 x 50

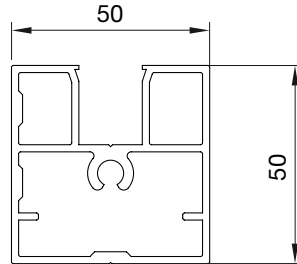

STX 8112

Glasprofiel 50 x 50 glasdikte 6.6.2

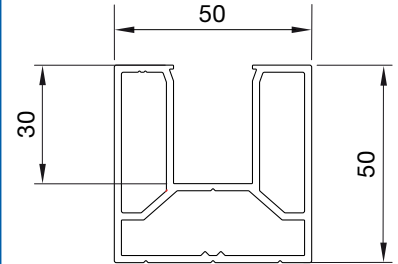

STX 8120

Glasprofiel 50 x 45

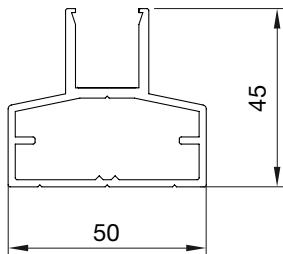

STX 8130

Glasprofiel 55 x 32

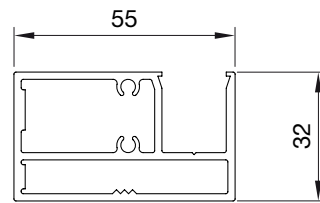

STX 8131

Glasprofiel 103 x 26

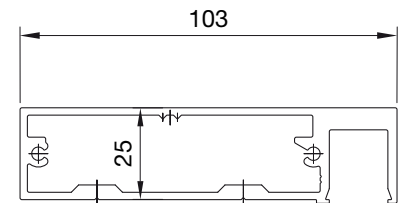

STX 8151

Glasprofiel Ø 40

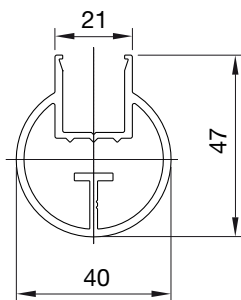

STX 8150

Glasprofiel Ø 30

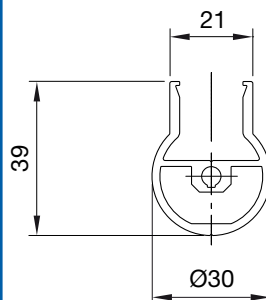

STX 8160

H-profiel 50 x 20

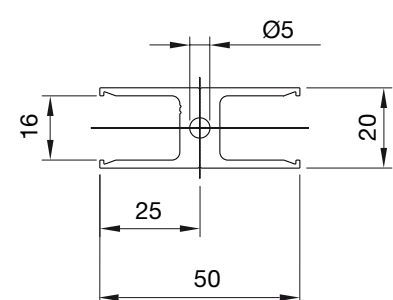



- voor trappen, balkons en galerijen
- voor binnen- en buitentoepassing
- materiaal:
 - gemoffeld staal
 - gemoffeld aluminium
 - geanodiseerd aluminium
- bovenleuning:
 - staal
 - aluminium
 - hout
- voldoet aan het Bouwbesluit
- optisch quasi balusterloos hekwerk is mogelijk



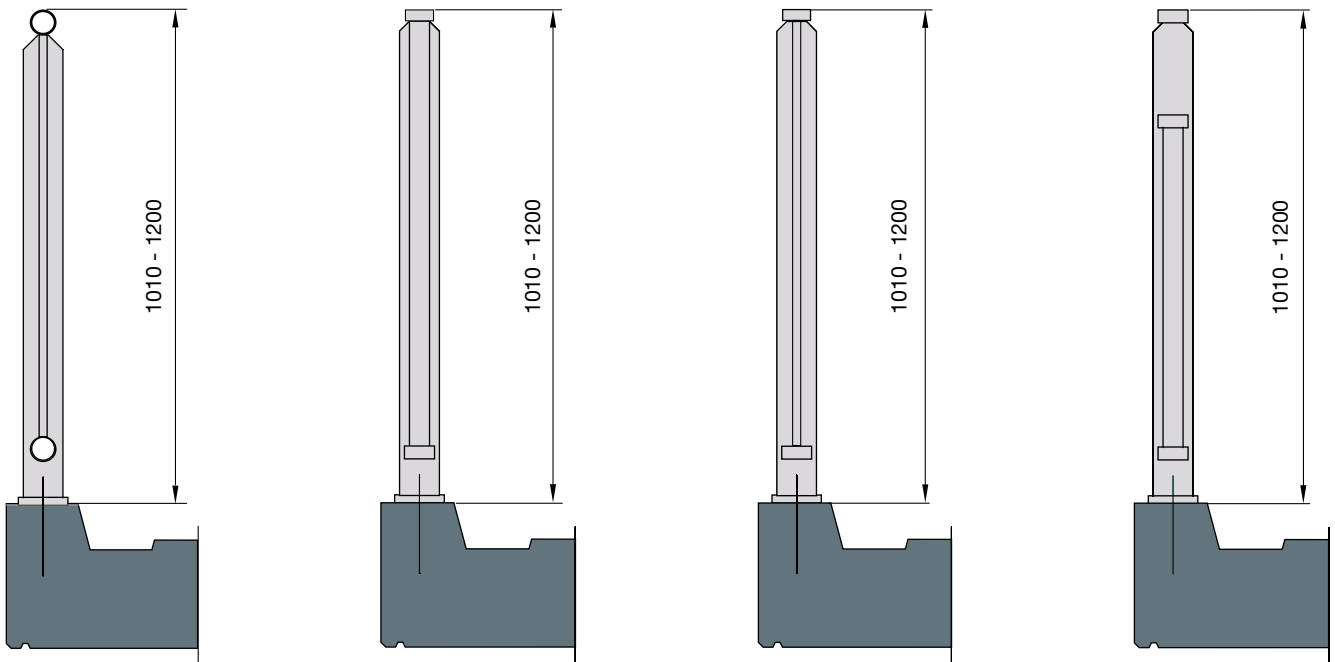
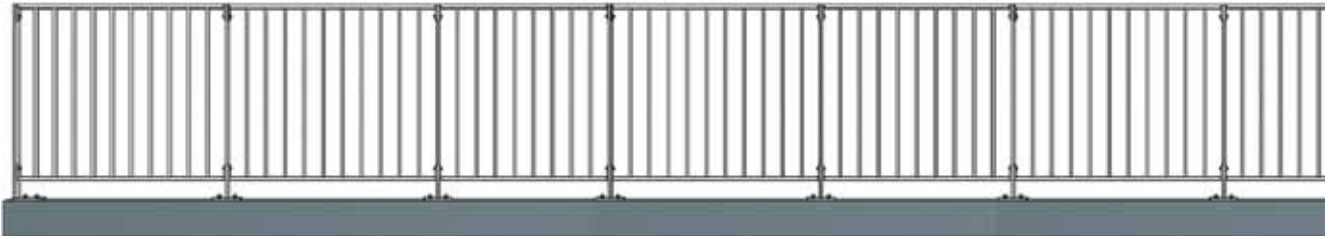

Technische informatie

Type:	Rhodium
Baluster:	stripbaluster
Balusterafstand:	maximaal 1700 mm
Boven- en onderregel:	rechthoekig kokerprofiel
Materiaalkeuze balusters:	- staal, thermisch verzinkt en/of gemoffeld in RAL kleur - aluminium gemoffeld in RAL kleur
Materiaal lamellen/spijlen:	- stalen koker 40 x 10 mm - thermisch verzinkt en/of gemoffeld in RAL kleur - aluminium koker 44 x 12 mm gemoffeld in RAL kleur of geanodiseerd - buis Ø 25 mm gemoffeld in RAL kleur of geanodiseerd
Lijnlast:	0,8 kN/m

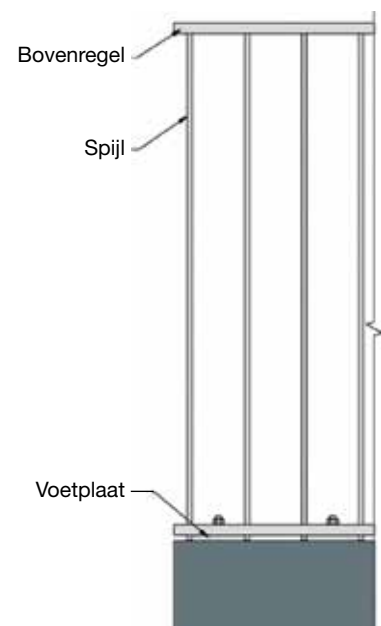

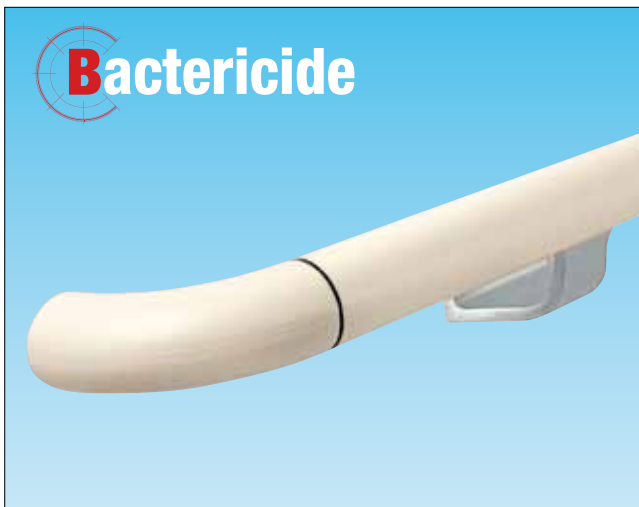

Kunststof leuningen

- voor gangen in o.a. ziekenhuizen en verzorgingshuizen
- ook toepasbaar als trapleuning
- onderhoudsvrij
- bactericide (bacteriedodend)
- UV gestabiliseerd en ozonbestendig
- leverbaar in 40 kleuren
- inclusief inmeten en montage
- levering losse componenten mogelijk



Houten leuningen

- voor gangen in o.a. ziekenhuizen en verzorgingshuizen
- natuurlijk materiaal waardoor een warme uitstraling ontstaat
- beuken is standaard houtsoort, overige houtsoorten op aanvraag afhankelijk van de hoeveelheid.
- fabrieksmatig afgewerkt met een duurzaam UV-bestendig, meervoudig laksysteem
- inclusief inmeten en montage
- levering losse componenten mogelijk





RVS leuningen

- past vanwege haar neutrale kleur in vrijwel elk interieur
- ook toepasbaar als trapleuning
- chique uitstraling
- lange levensduur
- inclusief inmeten en montage
- levering losse componenten mogelijk

































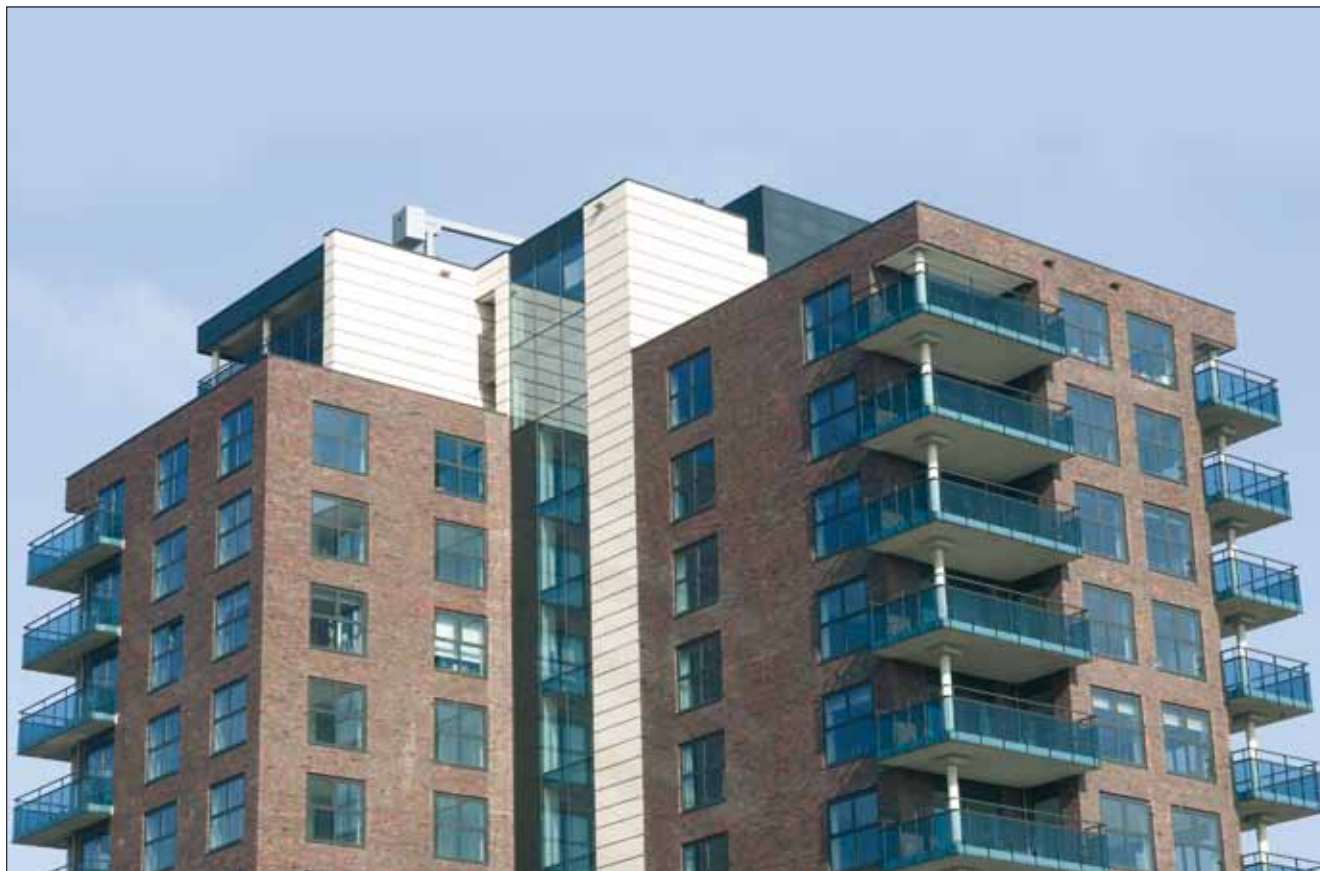











Het Storax leveringsprogramma

- entreematten
- schoonloopzones
- antislip
- glasbalustrades
- leuningen en hekwerken
- roosters
- lamellenwand
- zonwering
- hoekbeschermers
- muurbescherming
- vloerluiken
- vluchtluiken
- dak- en inspectieluiken
- dakluikladders en schaartrappen
- brandwerende wandluiken en deuren
- voegprofielen
- trapneuzen
- tegelprofielen
- schopplaten en speciaal zetwerk
- plinten en vloerprofielen
- zwembadroosters