

# STORAX®

---

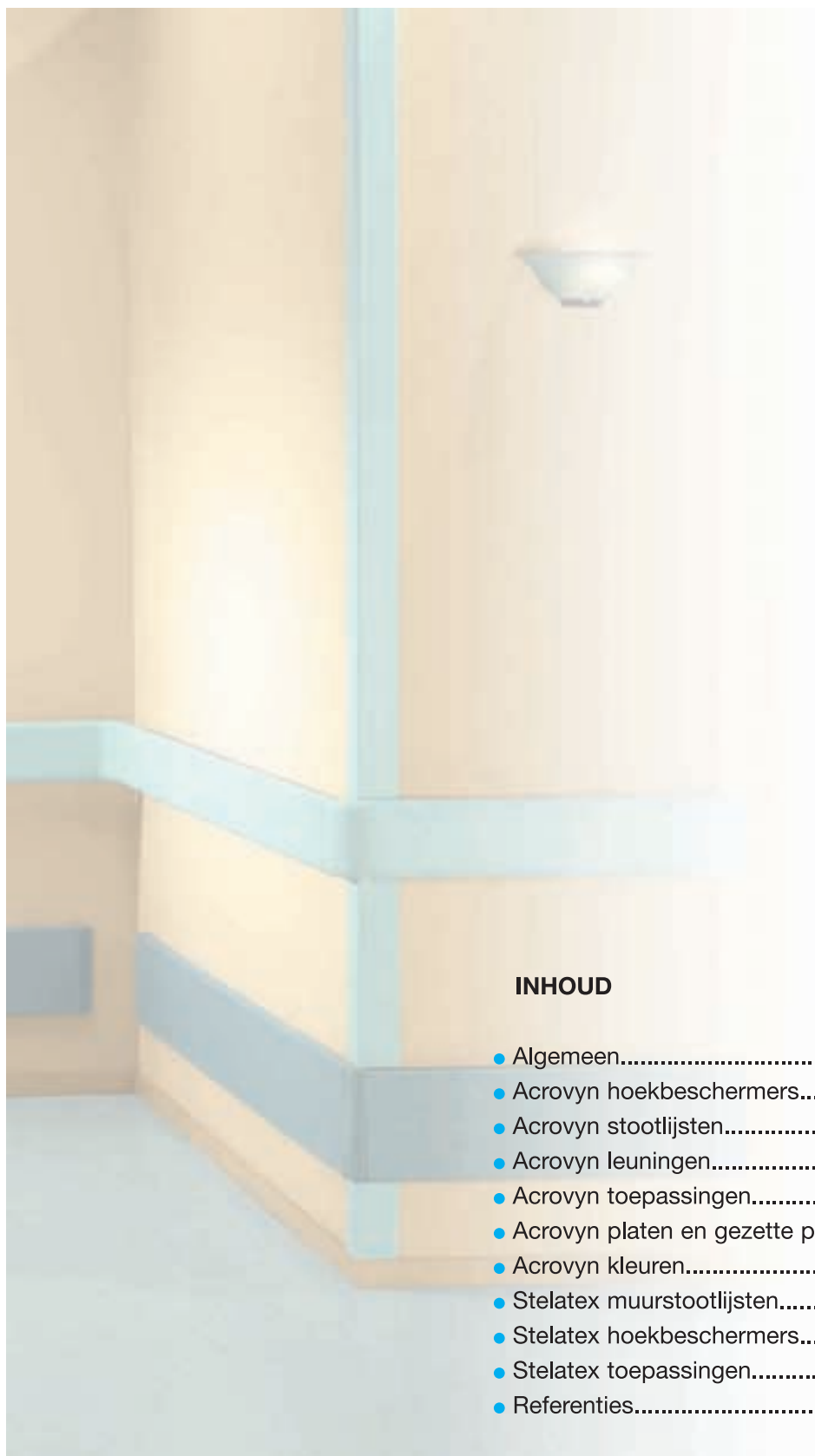

## MUURBESCHERMING



### INHOUD

- Algemeen.....pag. 1
- Acrovyn hoekbeschermers.....pag. 2-3
- Acrovyn stootlijsten..... pag. 4-6
- Acrovyn leuningen..... pag. 7-8
- Acrovyn toepassingen..... pag. 9-13
- Acrovyn platen en gezette profielen..... pag. 14-15
- Acrovyn kleuren..... pag. 16-17
- Stelatex muurstootlijsten..... pag. 18
- Stelatex hoekbeschermers..... pag. 19
- Stelatex toepassingen..... pag. 20
- Referenties..... pag. 21

## Algemeen

Het Acrovyn® muurbeschermingssysteem is door haar unieke concept al meer dan 30 jaar een betrouwbare en esthetisch verantwoorde oplossing ter voorkoming van beschadigingen in gebouwen.

## Systeem

Doorlopende geëxtrudeerde aluminium profielen welke direct of door middel van afstandhouders tegen de muur worden bevestigd. Over de aluminium onderprofielen wordt een vinyl beschermprofiel geklikt. Door het kliksysteem hebben de vinylprofielen een verende, schok-absorberende werking waardoor stoten kunnen worden opgevangen zonder beschadiging van de ondergrond. Het Acrovyn® muurbeschermingssysteem omvat de volgende profielseries:

- **hoekbeschermers:** type SSM-20, SM-20, SM-20M, FSP-20, SO-50V, SO-75, SO-50, SO 30
- **muurstootlijsten:** type FR-225, SCR-50M, SCR-80M, SCR-50, SCR-80, AR-170L
- **stootplaten:** type TP-300, TP-200, TP-150, TP-100
- **leuningen:** type HRO-6, HRB-20, HRB-35, HRB-4C
- **deurschopplaten en gezette profielen**
- **Stelatex muurstootlijsten:** type 150 W 20, 200 W 30, 60 B, 75 D
- **Stelatex hoekbeschermers:** type 75 C, 100 C.

## Toepassing

Overall waar door rolstoelen, brancards, bedden, dienwagens e.d. beschadigingen ontstaan aan hoeken, wanden, kozijnen en kolommen in ziekenhuizen, verpleeg- en bejaardenhuizen, restaurants, kantoren, supermarkten, banken, hotels, scholen, zwembaden, sporthallen, kazernes, etc.



## Materiaal

**Onderprofiel:** geëxtrudeerd aluminium kwaliteit Al.Mg.Si.0,5 (50 ST).

**Beschermprofiel:** geëxtrudeerd slagvast kunststof op vinylbasis.

## Sterkte

De Acrovyn® beschermingsprofielen hebben een zeer sterke acryl/vinyl legering met graniet structuur. Deze legering is slag-, kras- en slijtvast en toch flexibel, zodat de zwaarste klappen kunnen worden opgevangen en verwerkt, zonder de wanden te beschadigen.

Het Acrovyn® -systeem heeft een slagvastheid van 75 kg/cm<sup>2</sup>.

De Acrovyn® muurbeschermers bieden een schokbescherming van 25 kg/cm<sup>2</sup>.

## Standaardlengten

**Hoekbeschermers:** 3.000 mm. **Muurstootlijsten:** 4.000 mm.

## Kleuren

**Standaardkleuren profielen:** zie kleurenschema pag. 16 en 17.

**Standaardkleuren schopplaten:** volgens stalenkaart.

## Brandwering

Acrovyn® voldoet aan de Euroklasse volgens classificatie EN 13501-1(B-S<sub>2</sub>-d0).

## Onderhoud

Acrovyn® beschermprofielen zijn bestand tegen corrosie, chemicaliën, oplos- en reinigingsmiddelen en kunnen daardoor met alle normale schoonmaakartikelen worden gereinigd.

## Hygiëne

De vinylprofielen zijn glad en niet poreus, zodat staphilococconen en bacteriën zich niet op het oppervlak kunnen ontwikkelen.

## Economisch

- **sterke onderhoudsvrije constructie**
- **snelle montage**
- **esthetische vormgeving met onzichtbare bevestiging**
- **veilig door afgeronde vorm en het ontbreken van schroeven aan het oppervlak**

## SSM-20

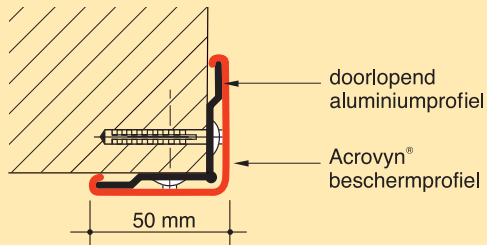

## SM-20

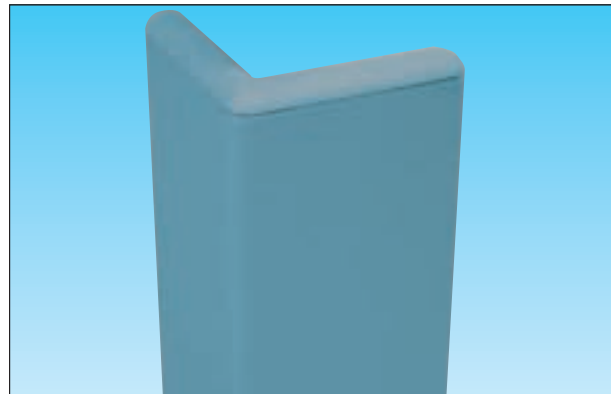
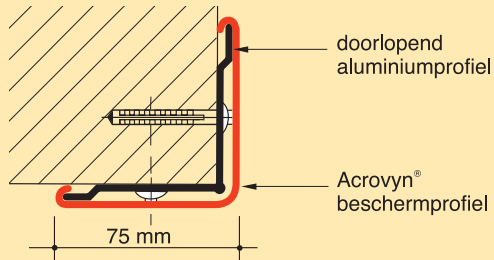

## SM-20M

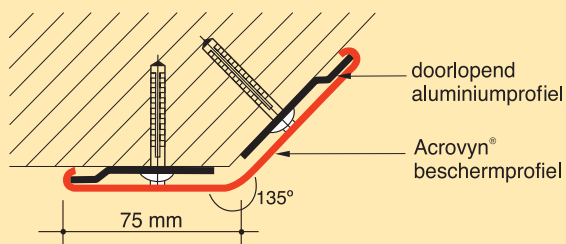

## FSP-20

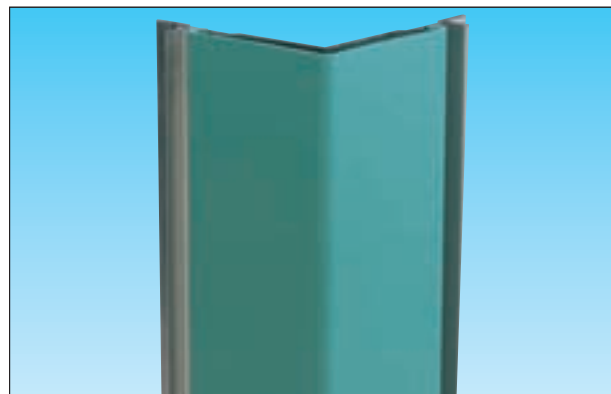
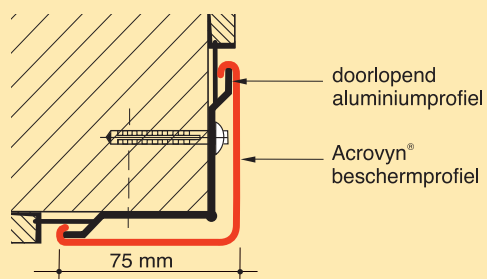

**SO-50V**

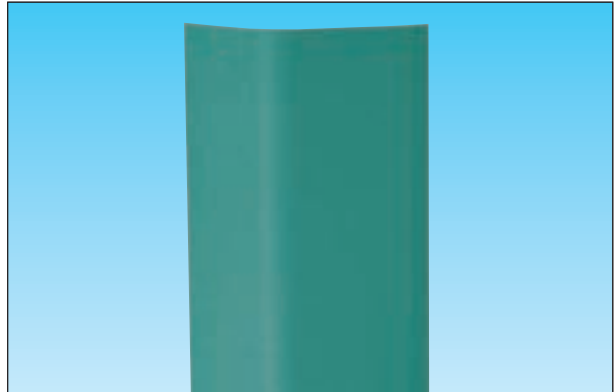
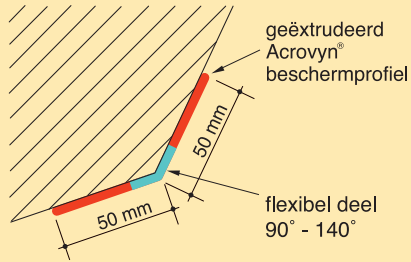

**SO-75**

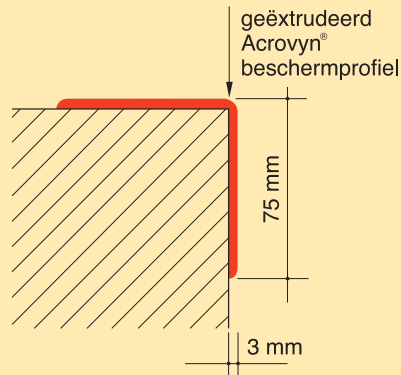

**SO-50**

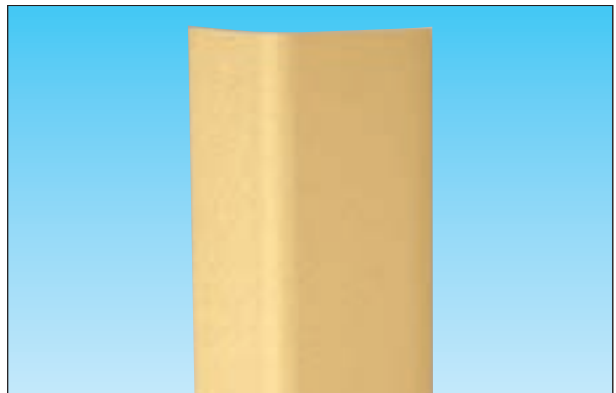
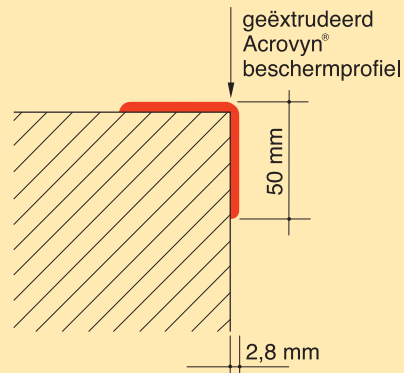

**SO-30**

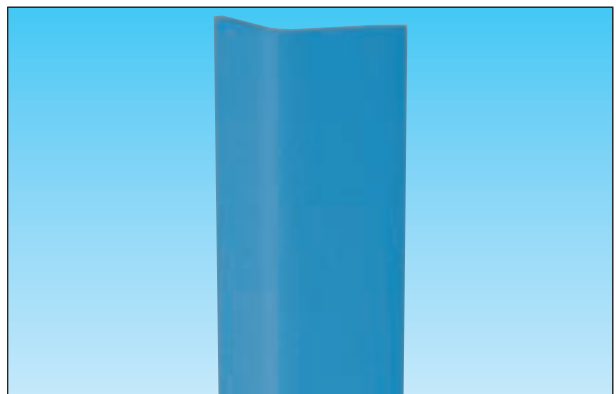
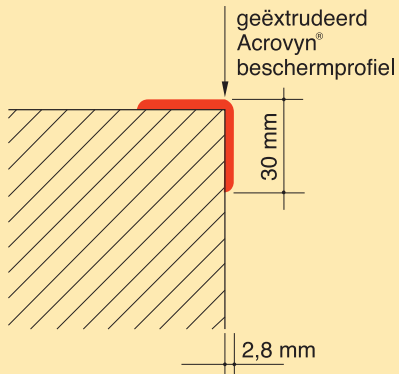

## FR-225

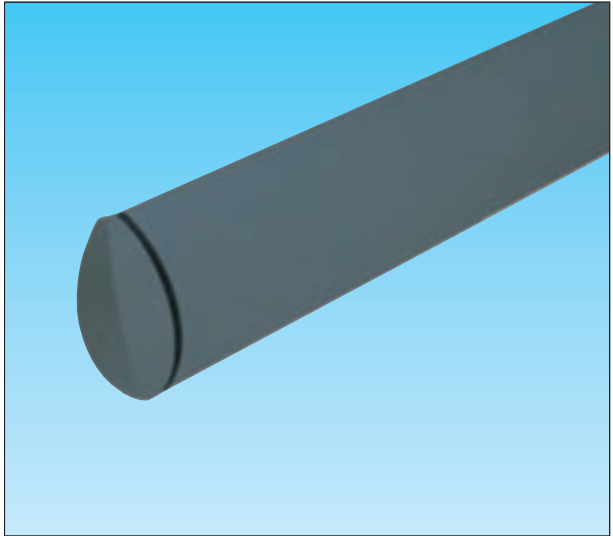
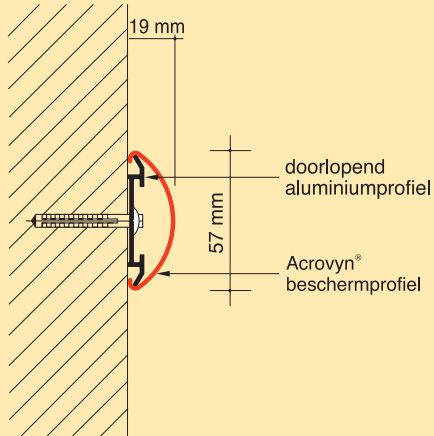

## SCR-50M

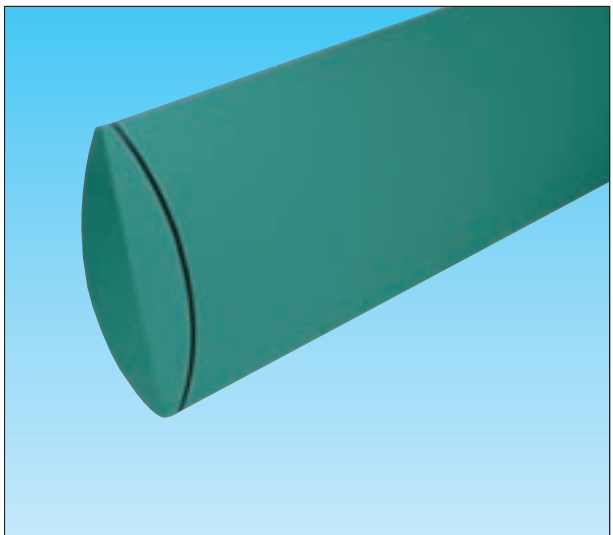
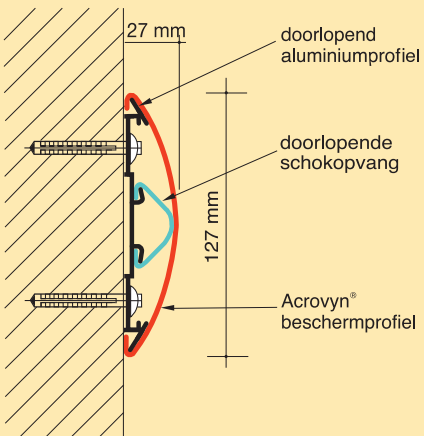

## SCR-80M

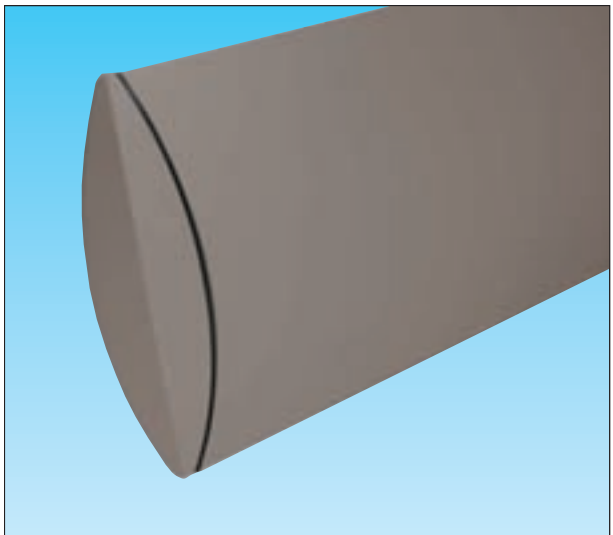
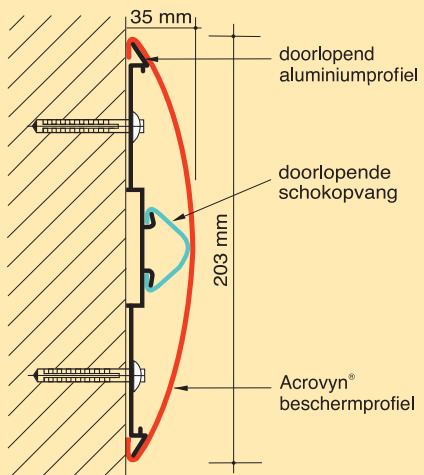

## SCR-50

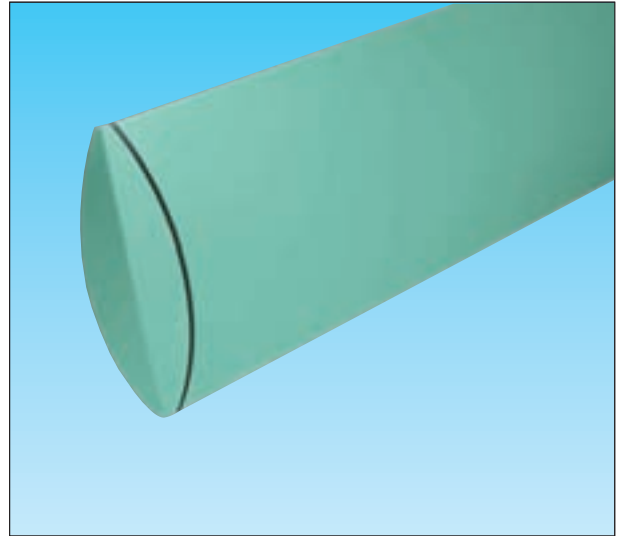
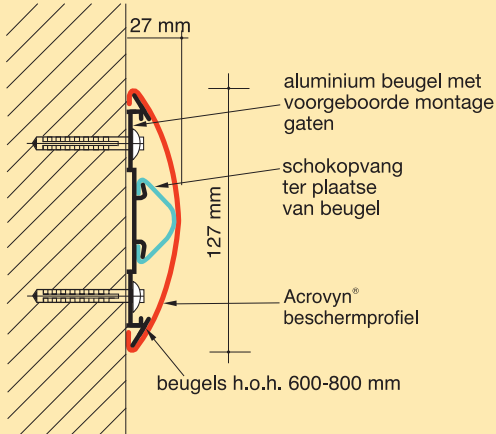

## SCR-80

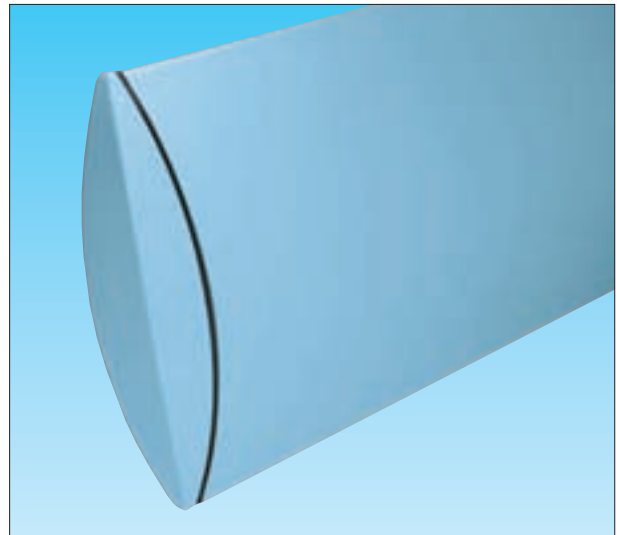
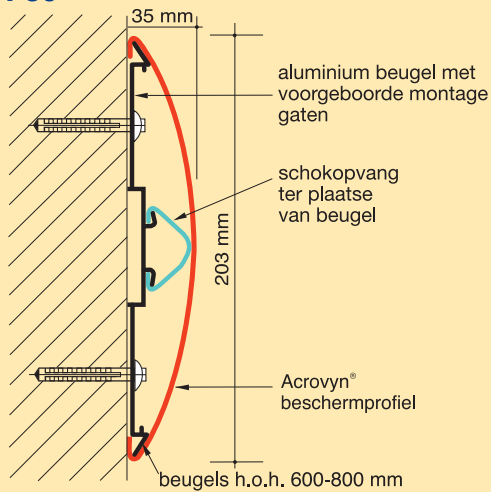

## AR-170L

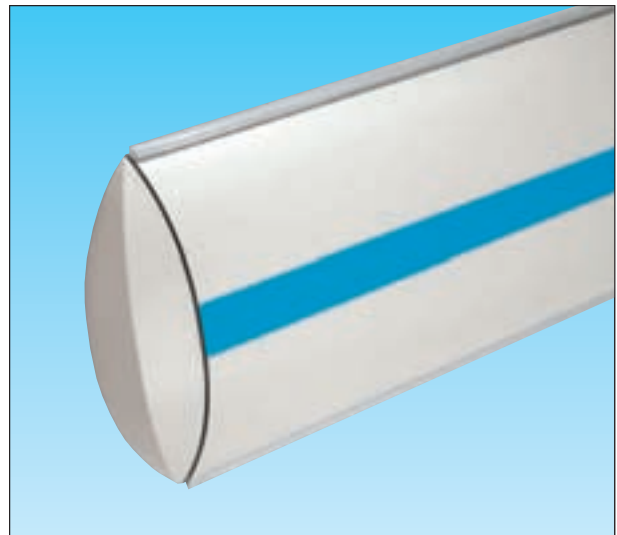
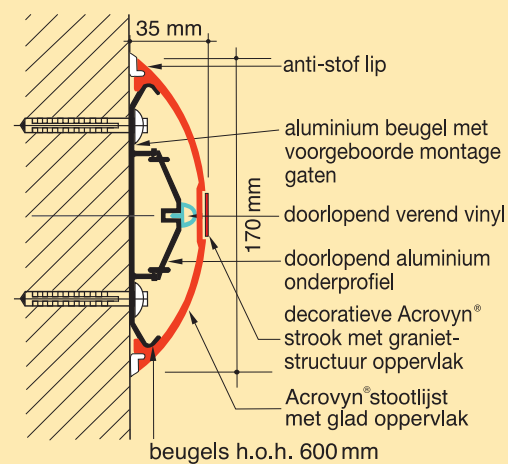

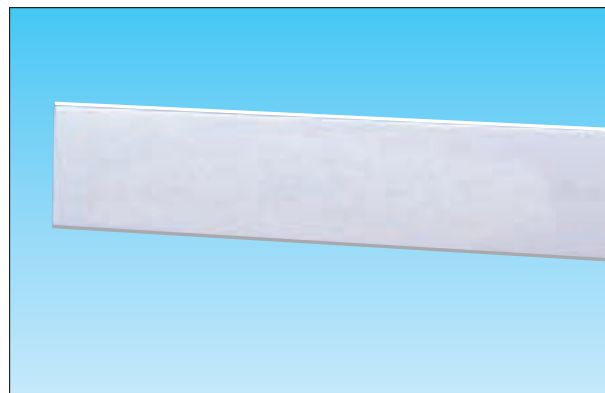
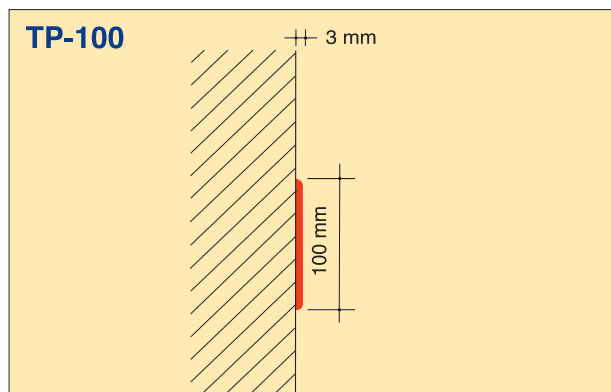
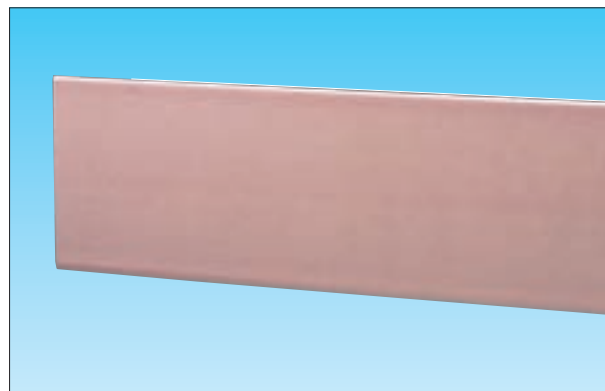
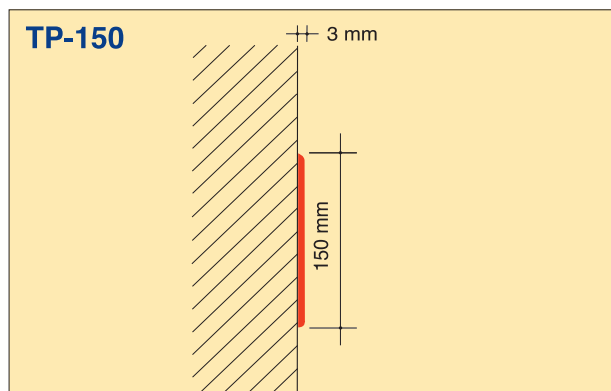
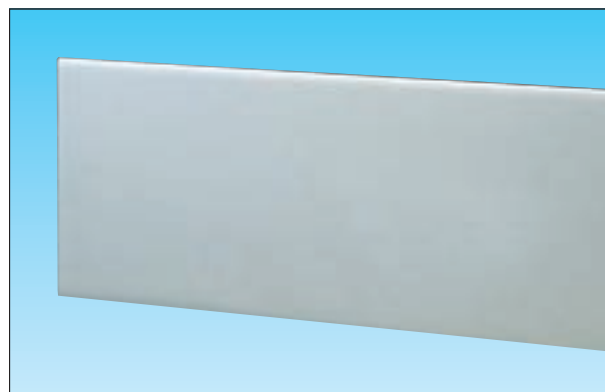
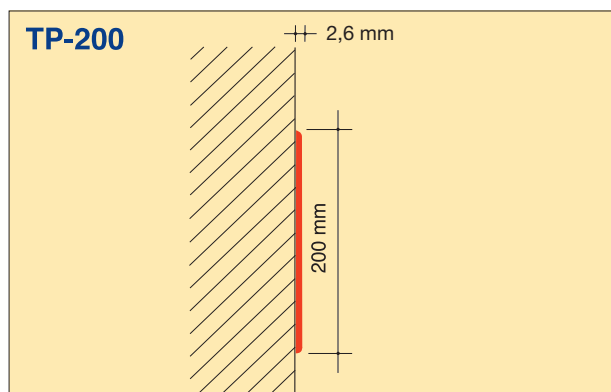
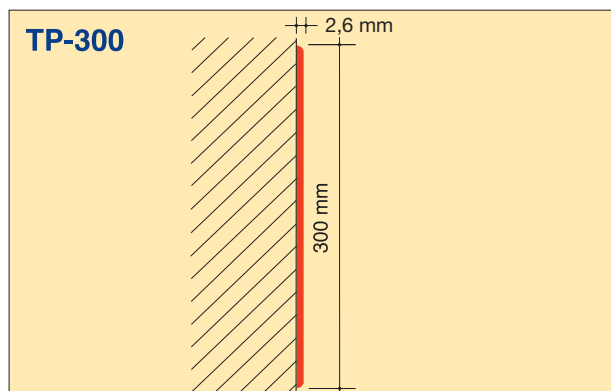

## HRO-6

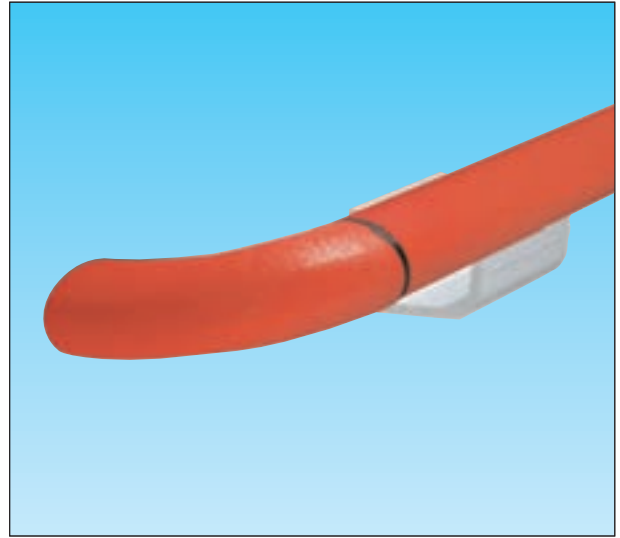
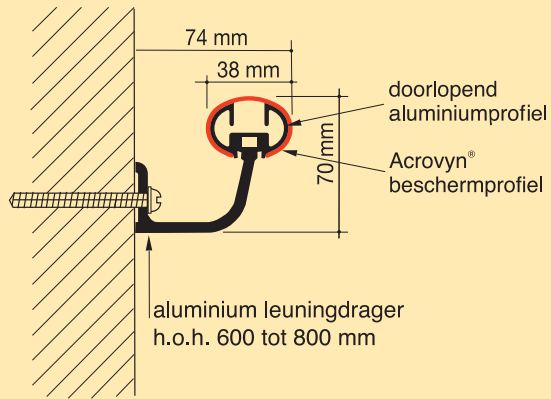

## HRB-20

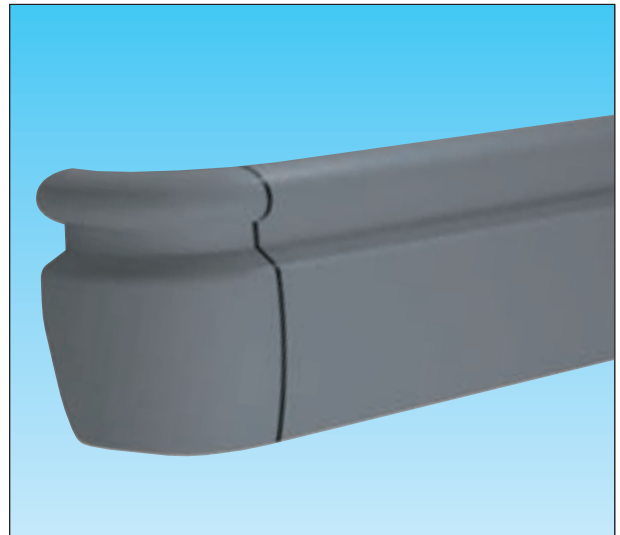
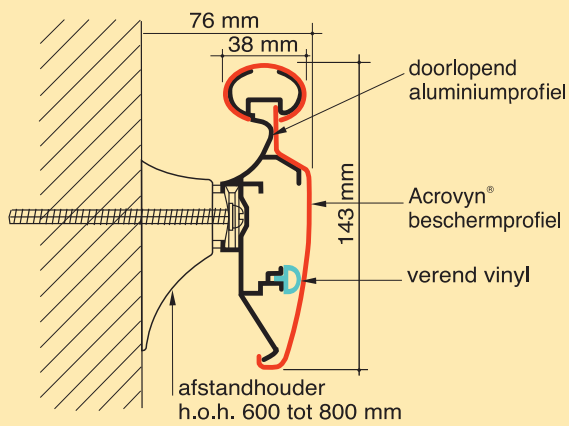

## HRB-35

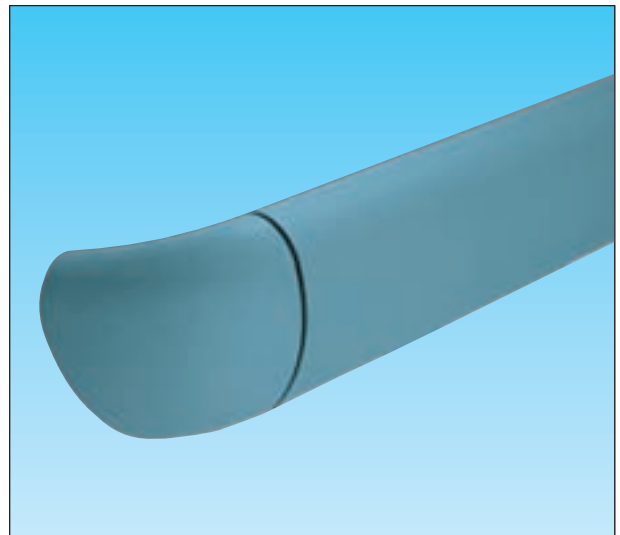
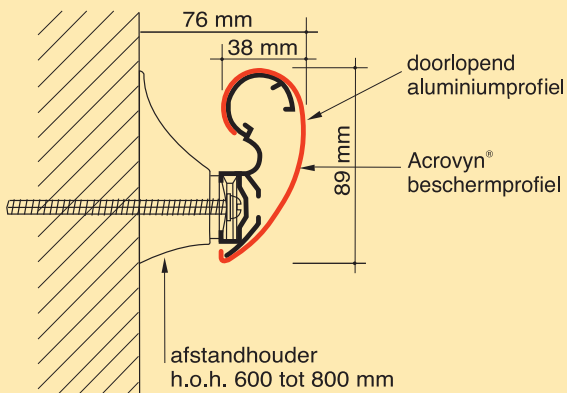

## HRB-4C

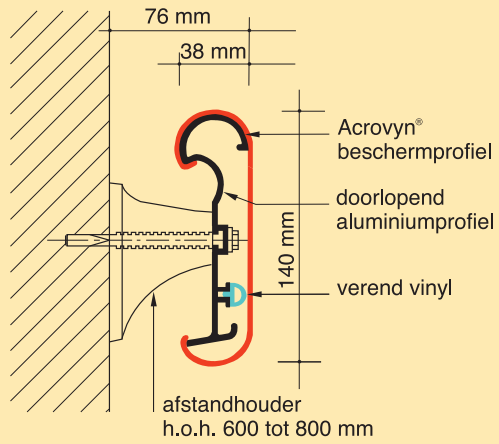









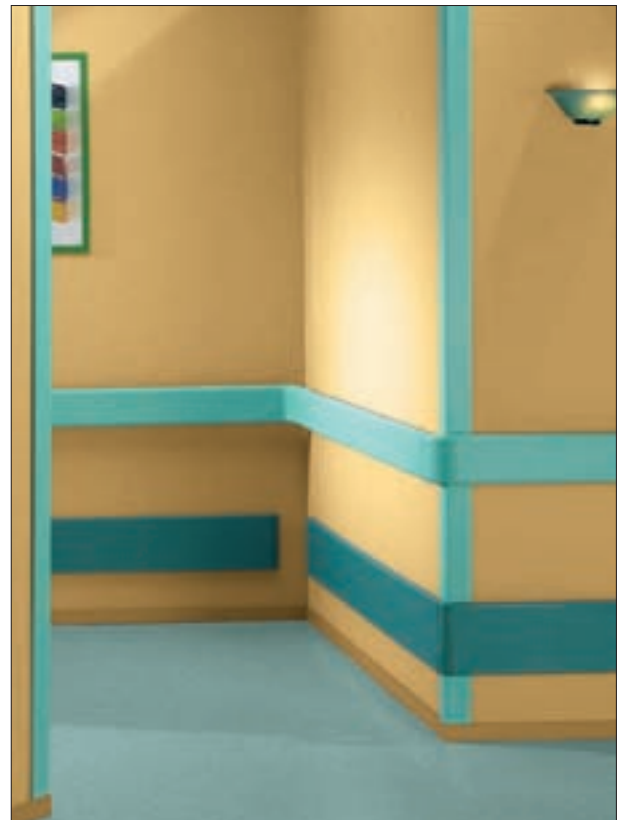

**Materiaal:** Acrovyn® is een sterke, kras-, en slagvaste acryl-vinyl legering.

**Dikte:** 2 mm.

**Oppervlak:** volgens monsterkaart.

**Brandwerendheid:** Acrovyn® voldoet aan de Euroklasse volgens classificatie EN 13501-1(B-S<sub>2</sub>-d0).

**Hygiëne:** Acrovyn® deurschopplaten zijn glad en niet poreus zodat staphilococconen en bacteriën zich niet op het oppervlak kunnen ontwikkelen.

**Onderhoud:** Acrovyn® is bestand tegen corrosie, chemicaliën en oplos- en reinigingsmiddelen en kan met de gebruikelijke schoonmaakmiddelen gereinigd worden.

**Leveringsvorm:**

- standaardplaten standaard kleur: 3.00 x 1.30 mtr.
- standaardplaten hout- en metaalkleur: 3.00 x 1.25 mtr.
- op maat gezaagd.
- als gezet profiel.

**Kleuren:** naar keuze volgens kleurenkaart.

- Acrovyn® deurschopplaten en speciaal gezette profielen kunnen desgewenst worden geleverd met afgeschuinde zijden.
- Acrovyn® deurschopplaten en speciaal gezette profielen worden ongeboord geleverd. Voor de verlijming adviseren wij Storax sealer 302.

voorbeeld gezet profiel



kozijnbescherming

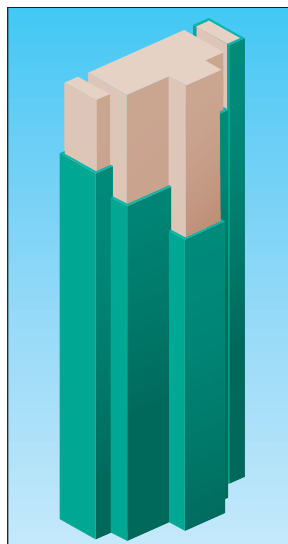

gezette profielen

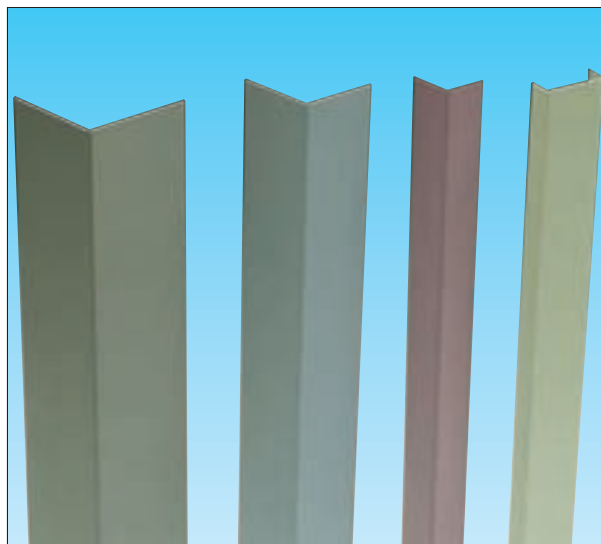

deurbescherming



muurbescherming





## 30 decoratieve kleuren

De werkelijke kleuren kunnen afwijken van de afbeeldingen. Vraag daarom zonnodig onze materiaalmonsters.

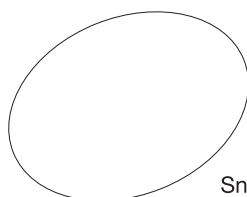
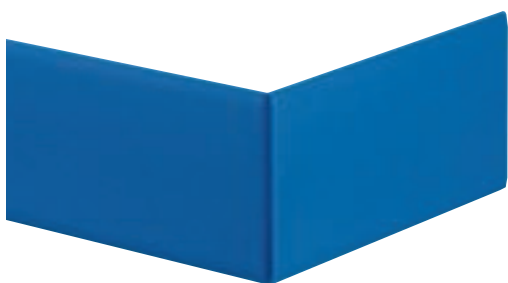
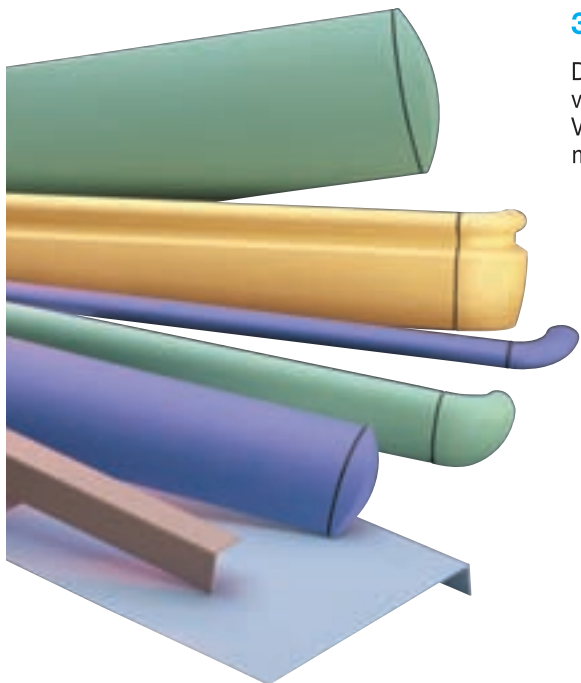

**9003**  
Sneeuw wit



**100**  
Gebroken wit



**101**  
Crème



**14**  
Mimosa



**16**  
Geel

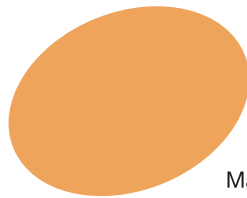

**17**  
Mandarijn

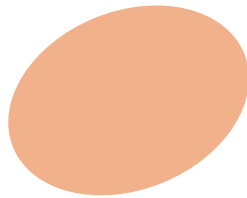

**18**  
Kreeft

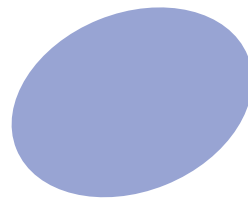

**663**  
Violet

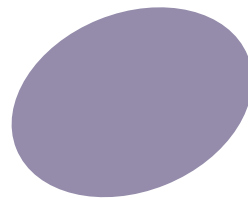

**20**  
Lila

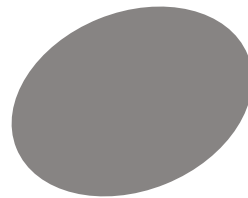

**26**  
Taupe

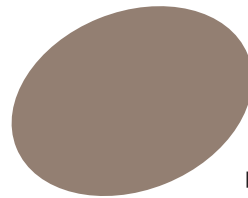

**105**  
Mokka

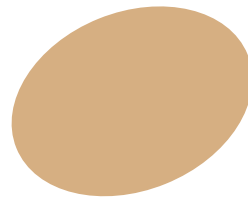

**15**  
Oker

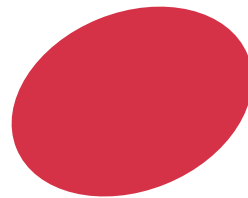

**845**  
Rood

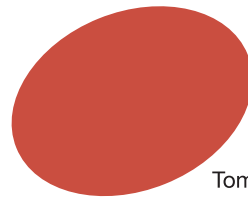

**19**  
Tomatenrood

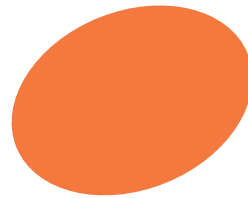

**2012**  
Zalm



**801**  
Wolkengrijs

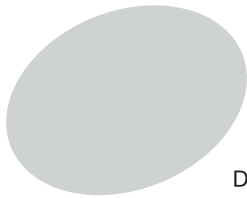

**24**  
Duifgrijs

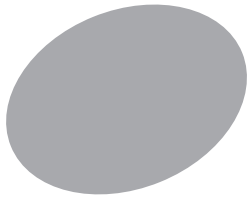

**136**  
Grijs

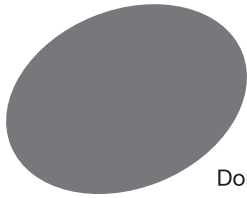

**162**  
Donkergrijs

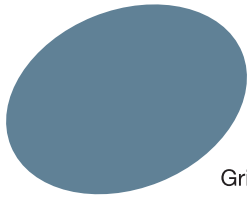

**25**  
Grijsblauw

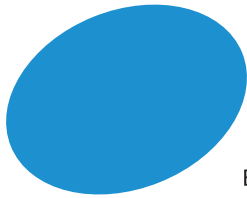

**112**  
Blauw

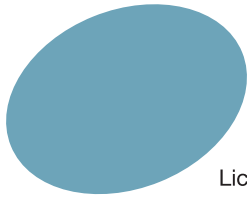

**111**  
Lichtblauw

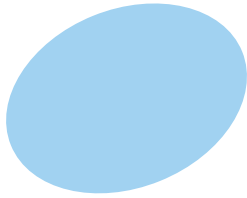

**11**  
Aqua

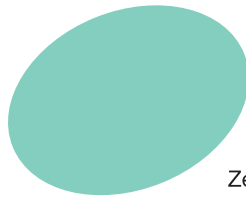

**10**  
Zeegroen

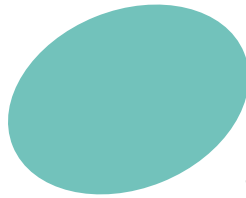

**879**  
Jade

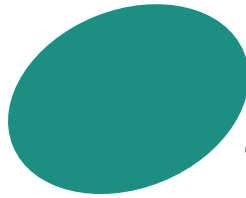

**6033**  
Mint

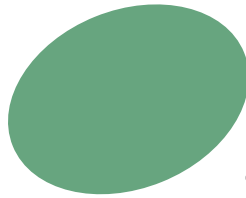

**23**  
Groen

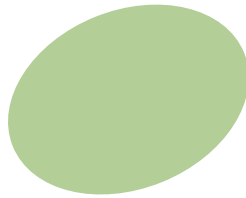

**22**  
Anijs

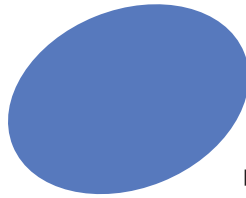

**12**  
Kobalt

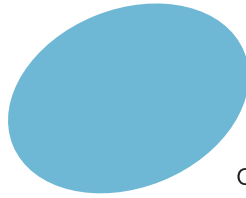

**21**  
Oceaan

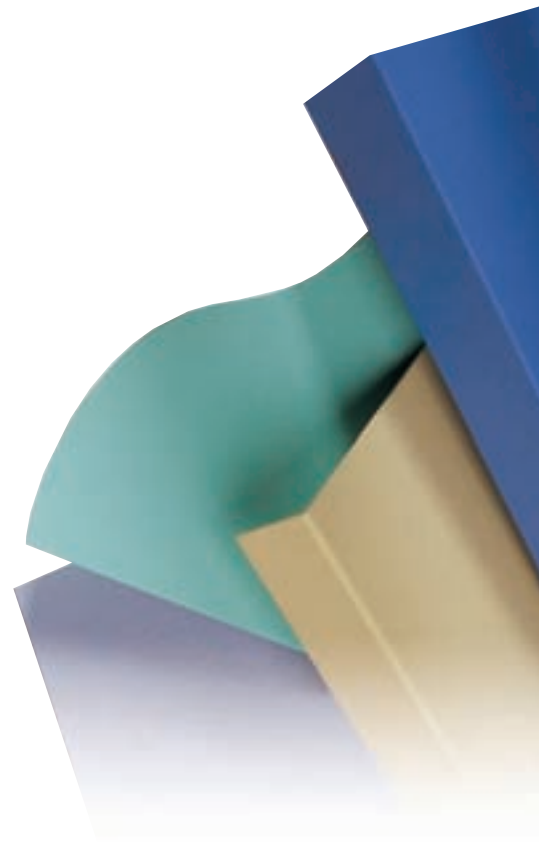

### Algemeen

STELATEX muurstootlijsten zijn speciaal ontworpen om wanden die blootstaan aan beschadigingen door voertuigen zoals vrachtwagens en vorkheftrucks te beschermen.

### Materiaal

Schokabsorberend elastomeer.

### Toepassingen

Stootlijst type **200 W 30** kan rondom zuilen en in bochten aangebracht worden door middel van een stalen trekband.

Tevens kan een reflecterende zelfklevende strip worden aangebracht. Stootlijst **60 B** en **75 D** zijn bestemd voor horizontaal of verticaal gebruik op vlakke of zeer licht gebogen oppervlakten.

Zij kunnen tevens achter op voertuigen worden gemonteerd.

**Standaardlengten:** 3.000 mm

Eindstukken en afdekplugges zijn leverbaar voor type **75 D**.

Bevestigingsmateriaal wordt niet meegeleverd.

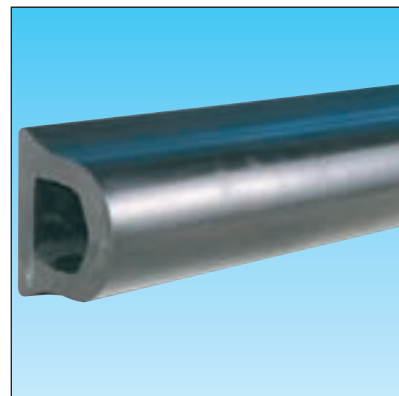
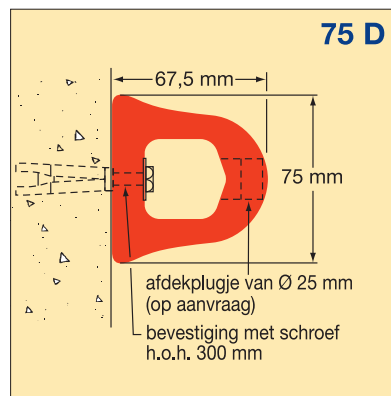
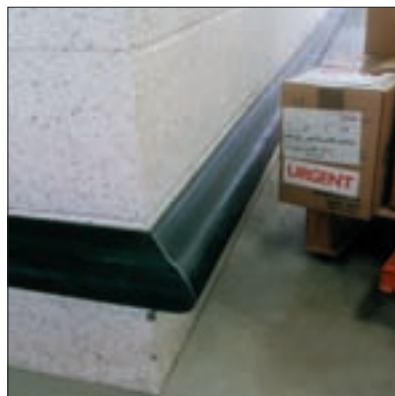
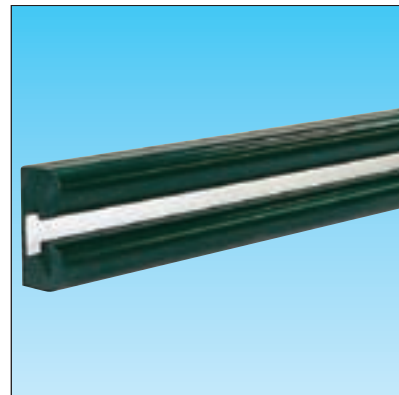
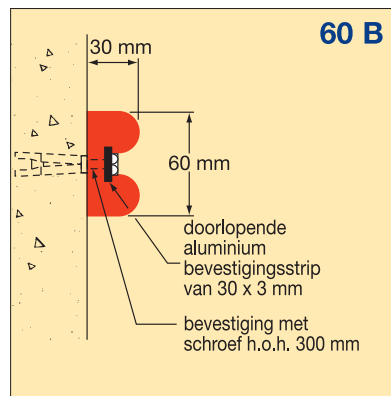
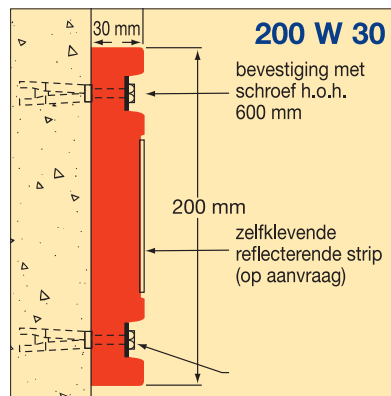
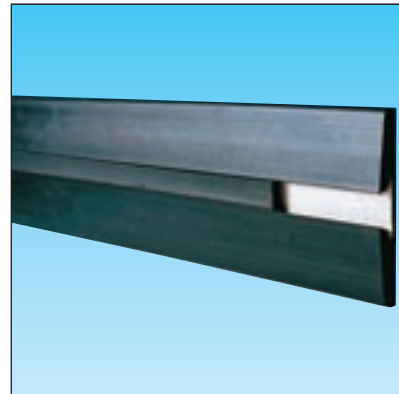
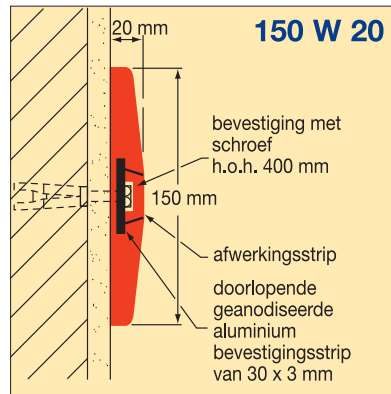



### Algemeen

STELATEX hoekbeschermers bieden een uitstekende bescherming tegen beschadigingen aan hoeken en zuilen, speciaal in parkeergarages, opslagplaatsen en industrieterreinen waar veel rijdend verkeer is. De profielen kunnen eenvoudig en snel worden geschroefd of gelijmd op bijna alle oppervlakten.

### Materiaal

Schokabsorberend elastomeer.

**Standaardlengten:** 3.000 mm

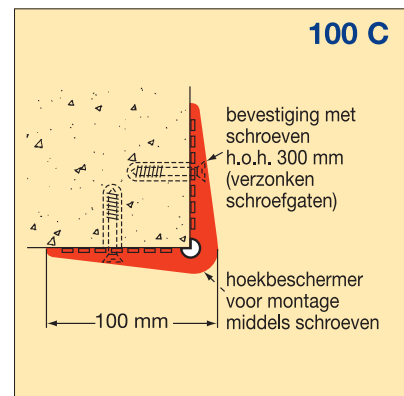
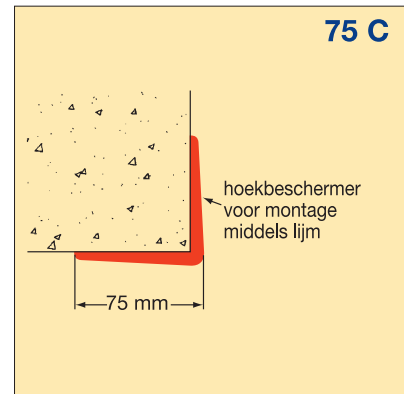



Almere	Flevo Ziekenhuis
Almere	Triade
Amsterdam	Fortis
Amsterdam	Novotel
Amsterdam	Sint Lucas Andreas Ziekenhuis
Apeldoorn	Belastingkantoor (Waltherboscomplex)
Breda	Amphia Ziekenhuis
Capelle a/d IJssel	Eneco
Capelle a/d IJssel	IJsselland Ziekenhuis
Den Bosch	Kantoor Essent
Den Haag	Congresgebouw
Den Haag	Haagse Poort (Nationale Nederlanden)
Den Haag	KPN
Den Haag	Ministerie LMV
Den Haag	Ministerie VROM
Den Haag	Rode Kruis Ziekenhuis
Den Helder	Vliegbasis De Kooy
Didam	Symbion School
Doorn	Militair Revalidatie Centrum
Eindhoven	Diaconessenhuis
Elburg	's-Heerenloo
Enschede	Verpleeghuis Boulevard
Ermelo	Ziekenhuis Veldwijk
Geldrop	St. Anna Ziekenhuis
Gorinchem	Beatrix Ziekenhuis
Heerhugowaard	Verpleeghuis Zuiderwaard
Heerlen	Atrium Medisch Centrum
Heeswijk	Verpleeghuis Cunera
Helmond	Elkerliek Ziekenhuis
Hoofddorp	Wooncentrum De Ring
Horst	Nieuw Spraeiland
Houten	Woonzorgcentrum Het Haltna Huis
Leeuwarden	Bornia Herne
Leiden	Diaconessenhuis
Maastricht	Academisch Ziekenhuis
Middelburg	't Gasthuis
Nieuwegein	Antonius Ziekenhuis
Nunspeet	's-Heerenloo
Nijmegen	P.C.N.
Oosterwolde	Verpleeghuis Stellinghaven
Oss	St. Anna Ziekenhuis
Ridderkerk	Het Ronde Zand
Roosendaal	Charitas
Rosmalen	Verpleeghuis Mariaoord
Rotterdam	Antonius Binnenweg
Rotterdam	Ikazia Ziekenhuis
Rotterdam	Politiebureau De Noordhoek
Rotterdam	Zorgcentrum Simeon & Anna
Soest	Verpleeghuis Daelhoven
Stadskanaal	Refaja Ziekenhuis
Swalmen	Amaliahof
Terneuzen	Ziekenhuis De Honte
Tilburg	Zorgcentrum Padua
Utrecht	Huis aan de Vecht
Utrecht	SHBU locatie Zuylenstede
Valkenswaard	Verpleeghuis Kempenhof
Vredepeel	JADC op Luchtmachtbasis
Vries	Stichting De Brink
Weert	Zorgcentrum Van Berlo Heem/Ververshof
Wierden	Zorgcentrum Wierden
Winterswijk	Streekziekenhuis Koningin Beatrix
Wouw	Wazoco Aramis
Zaandam	Hoofdkantoor Albert Heijn
Zaandam	Zaans Medisch Centrum
Zandvoort	Huize in de Kostverloren
Zwolle	TNT Post
Zwijndrecht	Zorgcentrum Nebo

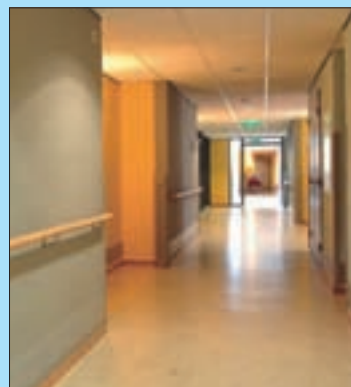



## Het Storax leveringsprogramma

- entreematten
- schoonloopzones
- glasbalustrades
- leuningen en hekwerken
- roosters
- lamellenwand
- zonwering
- hoekbeschermers
- muurbescherming
- vloerluiken
- dak- en inspectieluiken
- dakluikladders en schaartrappen
- voegprofielen
- trapneuzen
- tegelprofielen
- schopplaten en speciaal zetwerk
- plinten en vloerprofielen
- zwembadroosters